

[Online Classes : Megalecture@gmail.com](mailto:Megalecture@gmail.com)
www.youtube.com/megalecture
www.megalecture.com

www.youtube.com/megalecture

MEGA LECTURE

www.megalecture.com

TABLE OF CONTENTS

- 3 | CHAPTER 1
Motion in a Circle
- 3 | CHAPTER 2
Gravitational Fields
- 5 | CHAPTER 3
Ideal Gases
- 6 | CHAPTER 4
Temperature
- 7 | CHAPTER 5
Thermal Properties of Materials
- 9 | CHAPTER 6
Oscillations
- 12 | CHAPTER 7
Electric Fields
- 13 | CHAPTER 8
Capacitance
- 14 | CHAPTER 9
Magnetic Fields
- 18 | CHAPTER 10
Electromagnetic Induction

20 | CHAPTER 11
Alternating Currents

22 | CHAPTER 12
Quantum Physics

24 | CHAPTER 13
Particle & Nuclear Physics

25 | CHAPTER 14
Direct Sensing

26 | CHAPTER 15
Electronics

29 | CHAPTER 16
Communication

32 | CHAPTER 17
Medical Imaging

NOTES

1. MOTION IN A CIRCLE

1.1 Radians

- **Radian:** one radian is the angle subtended at the center of the circle by an arc of length equal to the radius of the circle

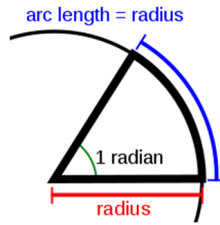

- **Angular displacement:** the angle through which an object moves through a circle

$$s = r\theta$$

1.2 Angular Velocity

- **Angular velocity:** the rate of change of the angular position of an object as it moves along a curved path

$$\omega = \frac{\theta}{t}$$

- **Period:** the time taken by the body to complete the circular path once

$$\omega = \frac{2\pi}{T} = 2\pi f$$

- Relating angular velocity and linear velocity:

$$v = \omega r$$

Example:

The drum of a spin dryer has a radius of 20cm and rotates at 600 revolutions per minute.

- Show that the angular velocity is 63 rad s⁻¹
- Calculate, for a point on the edge of the drum, its linear velocity

Solution:

Part (a)

Find rate per second

$$600\text{rev} : 60\text{sec}$$

$$10\text{rev} : 1\text{sec}$$

Hence 1 revolution is 0.1sec

Use angular velocity formula

$$\omega = \frac{2\pi}{0.1} = 62.8$$

Part (b)

Using relation between angular and linear velocity

$$v = \omega r = 62.8 \times 0.2 = 12.6 \text{ ms}^{-1}$$

1.3 Circular Motion

- A body moving in a circle at a constant speed changes velocity since its direction changes. Thus, it is accelerating and hence experiences a force.
- **Centripetal force:** resultant force acting on an object moving in a circle, always directed towards the center of the circle perpendicular to the velocity of the object

$$F = \frac{mv^2}{r} = mr\omega^2$$

- **Centripetal acceleration:** derived by equating Newton's 2nd law and centripetal force

$$a = r\omega^2 \text{ or } a = \frac{v^2}{r}$$

Example:

A horizontal flat plate is free to rotate about a vertical axis through its center.

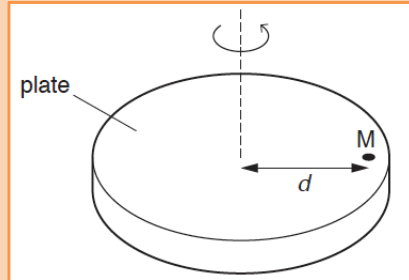

A mass M is placed on the plate, a distance d , 35cm, from the axis of rotation. The speed of rotation is increased from zero until the mass slides off the plate. The maximum frictional force F between the plate and the mass is given by the expression

$$F = 0.72W$$

Determine the maximum number of revolutions of per minute for the mass M to remain on the plate.

Solution:

The centripetal force on the particle is the frictional force so the max speed is when friction is at max

Centripetal Force = Frictional Force

$$\frac{Mv^2}{r} = 0.72W$$

Manipulating expression by adding ω and removing M

$$\frac{M(\omega r)^2}{r} = 0.72Mg$$

$$\omega^2 r = 0.72g$$

Find the angular velocity

$$\omega = \sqrt{\frac{0.72 \times 9.81}{0.35}} = 4.49 \text{ rad s}^{-1}$$

Find radians covered in a minute using ratios

$$4.49\text{rad} : 1\text{sec}$$

$$269.5\text{rad} : 60\text{sec}$$

Divide radians covered by 2π to find revolutions

$$\frac{269.5}{2\pi} = 42.9$$

$$\therefore 42 \text{ revolutions min}^{-1}$$

2. GRAVITATIONAL FIELDS

- Gravitational field an example of a field of force
- **Gravitational field strength:** gravitational force per unit mass

2.1 Describing a Gravitational Field

- For an isolated point mass, the gravitational field is spherical in shape with the mass at the center
- The gravitational field is described by the field lines. A field line is the path followed by a free unit mass in that gravitational field
- A higher density of field lines = a region of stronger field

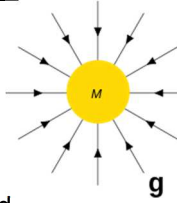

2.2 Newton's Law of Gravitation

- Gravitational force between two **point** masses is proportional to the product of their masses & inversely proportional to the square of their separation

$$F = \frac{GMm}{r^2}$$

G : Gravitational Field Constant = $6.67 \times 10^{-11} \text{ Nm}^2\text{kg}^{-2}$

- The gravitational force between two masses is independent of the medium separating the mass and is always an attractive force

{S05-P04}

Question 1:

The orbit of the Earth, mass $6.0 \times 10^{24} \text{ kg}$, may be assumed to be a circle of radius $1.5 \times 10^{11} \text{ m}$ with the Sun at its center, illustrated below. The time taken for one orbit is $3.2 \times 10^7 \text{ s}$.

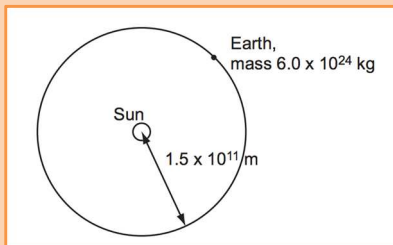

- Calculate the magnitude of the centripetal force acting on the Earth
- Determine the mass of the Sun

Part (a):

Firstly, calculate the angular velocity of the earth

$$\omega = \frac{2\pi}{T} = \frac{2\pi}{3.2 \times 10^7} = 1.96 \times 10^{-7}$$

Use centripetal force equation, $F = m\omega^2 r$

$$F = 6.0 \times 10^{24} \times (1.96 \times 10^{-7})^2 \times 1.5 \times 10^{11}$$

$$F = 3.46 \times 10^{22} \text{ N}$$

Part (b):

The centripetal force is provided by the gravitational force of the sun \therefore using Newton's inverse law

$$3.46 \times 10^{22} = \frac{GMm}{r^2}$$

Substitute values into the expression

$$3.46 \times 10^{22} = \frac{6.67 \times 10^{-11} \times M \times 6.0 \times 10^{24}}{(1.5 \times 10^{11})^2}$$

$$M = 1.95 \times 10^{30}$$

2.3 Gravitational Field Strength

- The gravitational field strength at a point is the gravitational force exerted per unit mass
- By equating $W = mg$ and Newton's Law of Gravitation

$$mg = \frac{GMm}{r^2}$$

$$\therefore g = \frac{GM}{r^2}$$

- By equating $W = mg$ and Newton's Law of Gravitation

2.4 Gravitational Potential

- The **gravitational potential** at a point is work done per unit mass in bringing a mass from infinity to the point

$$\phi = -\frac{GM}{r}$$

- The negative sign is because:

- Gravitational force is always attractive
- Gravitational potential reduces to zero at infinity
- Gravitational potential decreases in direction of field

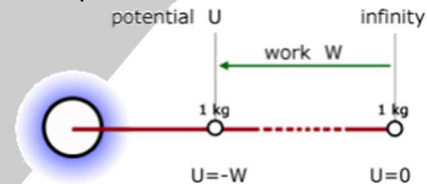

- On Earth's surface, we can use the equation $g.p.e = mgh$ however this is not true for masses far from Earth's surface because we assume g is constant

- Gravitational potential energy** of a mass m at a point in the gravitational field of another mass M , is the work done in bringing that mass m from infinity to that point

$$U = m\phi = -\frac{GM}{r}m$$

- The **gravitational potential energy difference** between two points is the work done in moving a mass from one point to another

$$\Delta U = m\phi_{final} - m\phi_{initial}$$

2.5 Centripetal Acceleration

- For an orbiting satellite, the gravity provides centripetal force which keeps it in orbit \therefore

$$\frac{GMm}{r^2} = \frac{mv^2}{r}$$

$$v^2 = \frac{GM}{r}$$

- \therefore velocity is independent of the mass of the satellite

2.6 Geostationary Orbits

- Geostationary orbit:**

- Equatorial orbit
- Period is 24hrs; same angular speed as Earth
- From West to East; same direction of rotation as Earth

- **Geostationary satellite** is one which always appears to be above a certain point on the Earth
- For a geostationary orbit: $T = 24$ hrs. and orbital radius is a fixed value from the center of the Earth
- However, mass of the satellite not fixed hence the k.e., g.p.e. and centripetal force are not fixed values
- A geostationary satellite is launched from the equator in the direction of rotation of the Earth (West to East) so that the axis of rotation of the satellite & Earth coincide

{W05-P04}

Question 1:

The Earth may be considered to be a sphere of radius 6.4×10^6 m with mass of 6.0×10^{24} kg concentrated at its center. A satellite of mass 650 kg is to be launched from the Equator and put into geostationary orbit.

- Show that the radius of the geostationary orbit is 4.2×10^7 m
- Determine the increase in gravitational potential energy of the satellite during its launch from the Earth's surface to the geostationary orbit.

Solution:

Part (a):

Centripetal force provided by gravity \therefore

$$\frac{GMm}{r^2} = \frac{mv^2}{r}$$

$$GM = v^2 r$$

Using angular velocity, substitute $v = \omega r$

$$GM = \omega^2 r^2 \times r$$

Substituting $\omega = \frac{2\pi}{T}$

$$GM = \frac{4\pi^2}{T^2} \times r^3$$

The time period is always 24 hours so in seconds

$$24 \text{ hours} = 24 \times 60 \times 60$$

Rearranging and substituting in values

$$r = \sqrt[3]{\frac{6.67 \times 10^{-11} \times 6.0 \times 10^{24} \times (86,400)^2}{4\pi^2}}$$

$$= 4.2 \times 10^7$$

Part (b):

Using the following expression

$$\Delta U = \left(-\frac{GM}{r}m\right)_{final} - \left(-\frac{GM}{r}m\right)_{initial}$$

$$= GM \left(-\frac{m}{r_{final}} + \frac{m}{r_{initial}}\right)$$

Substitute values

$$= 6.67 \times 10^{-11} \times 6.0$$

$$\times 10^{24} \left(\frac{650}{6.4 \times 10^6} - \frac{650}{4.2 \times 10^7}\right)$$

$$= 3.45 \times 10^{10} \text{ J}$$

2.7 Escape Velocity of a Satellite

- By conservation of energy,
Initial K.E. + Initial G.P.E = Final = 0

$$\frac{1}{2}mv^2 - \frac{GMm}{r} = 0$$

$$\text{Thus escape velocity} = \sqrt{\frac{2GM}{r}}$$

- Escape velocity is the speed a satellite needs to get into orbit however not used as it is a huge value and satellites have engines so provide thrust to reach height of orbit

2.8 Weightless

An astronaut is in a satellite orbiting the Earth, reports that he is 'weightless', despite being in the Earth's gravitational field. This sensation is because

- Gravitational force provides the centripetal force: the gravitational force is equal to the centripetal force

$$\frac{GMm}{r^2} = \frac{mv^2}{r}$$

- The sensation of weight (reaction force) is the difference between F_G and F_C which is zero.
- Therefore, astronaut feels weightless

3. IDEAL GASES

3.1 The Avogadro Constant

- **Avogadro's constant (N_A):** number of atoms present in 12g of carbon-12
- **A mole:** amount of substance containing same number of particles as in 12g of carbon-12

3.2 Equation of State

- **Ideal gas:** a gas which obeys the ideal gas equation for all values of P , V and T

$$pV = nRT$$

where n = amount of substance (no. of moles)

- Conditions for equation to be valid:
 - fixed amount of gas
 - ideal gas
- **Boyle's Law:** $P \propto \frac{1}{V}$ hence $pV = \text{constant}$
- **Charles's Law:** $V \propto T$ hence $\frac{V}{T} = \text{constant}$

$$\therefore \frac{P_1 V_1}{T_1} = \frac{P_2 V_2}{T_2}$$

3.3 Kinetic Theory of Gases

Molecular movement causing pressure:

- Molecules hit and rebound off the walls of the container
- The change in momentum gives rise to force
- Many impulses averaged to give constant force and hence pressure

- From observation of a smoke cell under a microscope, the Brownian motion of particles (haphazard, random) provides evidence of movement of gas molecules

Basic Assumptions of the Kinetic Theory of Gases

- Gas contains large no. of particles
- Negligible intermolecular forces of attraction
- Volume of particles negligible compared to container
- Collisions between particles are perfectly elastic
- No time spent in collisions
- Average k.e. directly proportional to absolute temp.

3.4 Molecular Movement and Pressure

- Consider a cube of space with length L and a particle moving with velocity c
- When particle collides with wall, velocity is reversed and change in momentum is

$$\Delta p = m(c - (-c)) = 2mc$$

- Distance moved by particle is $= L + L = 2L$
- Using speed-distance formula, time between collisions is

$$t = \frac{2L}{c}$$

- Rate of change of momentum (i.e. force) is

$$F = \frac{\Delta p}{t} = \frac{2mc}{\frac{2L}{c}} = \frac{mc^2}{L}$$

- Using above quantities to find pressure

$$P = \frac{F}{A} = \frac{\frac{mc^2}{L}}{L^2} = \frac{mc^2}{L^3} = \frac{mc^2}{V}$$

- Rearrange to $pV = mc^2$

- Considering N particles in 3D (hence the $\frac{1}{3}$) with average speed $\langle c \rangle$,

$$pV = \frac{1}{3}Nm \langle c \rangle^2 \text{ or } p = \frac{1}{3}\rho \langle c \rangle^2$$

- **Mean square velocity** $\langle c \rangle^2$: mean value of the square of the velocities of the molecules

3.5 Kinetic Energy of a Molecule

- By equating the two formulae in pV , finding a relationship between E_k and T

$$nRT = \frac{1}{3}Nm \langle c \rangle^2$$

$$\frac{3nRT}{N} = m \langle c \rangle^2$$

Avogadro's constant, $N_A = \frac{N}{n}$

$$\frac{3RT}{2N_A} = \frac{1}{2}m \langle c \rangle^2$$

Boltzmann's constant, $k = \frac{R}{N_A}$

$$\frac{3}{2}kT = E_k$$

$$\therefore T \propto E_k$$

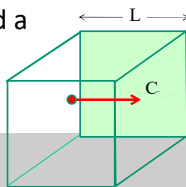

{S11-P41}

Question 2:

A balloon is filled with helium gas at a pressure of $1.1 \times 10^5 \text{ Pa}$ and a temp. of 25°C . The balloon has a volume of $6.5 \times 10^4 \text{ cm}^3$. Helium may be assumed to be an ideal gas. Determine no. of gas atoms in the balloon.

Solution:

Firstly, calculate number of moles

$$pV = nRT$$

$$n = \frac{pV}{RT}$$

Substitute information given converting to standard units i.e. m^3 and Kelvin

$$n = \frac{1.1 \times 10^5 \times 6.5 \times 10^4 \times (10^{-2})^3}{8.31 \times (25 + 273)} = 2.89$$

Use relationship between Avogadro's constant N_A and number of moles n to find number of particles N

$$N = N_A \times n$$

$$N = 6.02 \times 10^{23} \times 2.89 = 1.75 \times 10^{24}$$

4. TEMPERATURE

- Temperature **does not** measure the amount of thermal energy in a body:
 - Two objects of different masses made of the same material at the same temperature would have different amount of heat
 - When a substance melts or boils, heat is input but there is not temperature energy

4.1 Thermal Equilibrium

- Thermal energy is transferred from a region of higher temperature to a region of lower temperature
- **Thermal equilibrium:** a condition when two or more objects in contact have the same temperature so there is no net flow of energy between them (NB not equal internal energy because no. of molecules unknown)
- Regions of equal temperature are in thermal equilibrium

4.2 Measuring Temperature

- A physical property that varies with temperature may be used for the measurement of temperature e.g.
 - Change in volume of a liquid or gas
 - Change in pressure of a gas
 - Change in electrical resistance
 - Change in e.m.f. of a thermocouple
- Physical property should have the following qualities:
 - Change in property with temp. should be large enough to be measured accurately
 - Value of temperature recorded should be reproducible i.e. m.p. should be the same when measured a 2nd time

- Property being used must be suitable over temperature range being measured
- Should be able to be calibrated easily hence property should change uniformly with temperature

4.3 Thermodynamic Scale

- **Thermodynamic (Kelvin) scale:** theoretical scale that is independent of properties of any particular substance.
- Based on idea that average k.e. of particles of a substance increase with temperature and the average k.e. is same for all substances at a particular temp.

$$K = ^\circ C + 273.15$$

- **Absolute zero:** temperature at which a system has minimum internal energy (not zero) – impossible to remove any more energy – at 0 Kelvin
- **Triple point of pure water:** temp. at which water exists as vapor, liquid and solid – at 273.16 Kelvin (0.01°C)

4.4 Practical Thermometers

	Thermistor	Thermocouple
Advantages	Readings can be taken remotely	
	<ul style="list-style-type: none"> ● Very robust ● Fast response ● Accurate ● Sensitive at low temps. 	<ul style="list-style-type: none"> ● Faster response ● Wider range ● Small thermal capacity ● Physically small – readings taken at point ● Power supply not need
Disadvantages	Non-linear variation with temperature	
	<ul style="list-style-type: none"> ● Narrower range ● Slower response time than thermocouple ● Larger thermal capacity ● Larger in size ● Not suitable to measure varying temp. 	<ul style="list-style-type: none"> ● For accurate reading, a high resistance voltmeter required

5. THERMAL PROPERTIES OF MATERIALS

5.1 Kinetic Model of Matter

	Solid	Liquid	Gas
Structure	Regular lattice	More disordered than solid	Completely disordered
Attraction	Strong	Less than solid	Negligible
Motion	Vibrate about fixed point	Translational motion	Brownian – move at high speeds

5.2 Melting, Boiling and Evaporating

	Melting	Boiling	Evaporation
Occurrence	Throughout substance Fixed temp./pressure		On surface All temps.
Spacing & P.E.	Increases slightly	Increases significantly	
Temp. & K.E.	Constant during process		Remaining liquid cools

- Melting & boiling occurs without change in temp.:
 - Temp. is a measure of random K.E. of the particles
 - At phase transition all energy used to break bonds
 - No change in K.E. occurs so temp. does NOT change
- Cooling effect of evaporation:
 - Particles which escape are those with higher velocity so average KE of remaining substance decreases
 - Temp. = average KE ∴ overall temperature decreases

5.3 Specific Heat Capacity and Latent Heat

- **Specific heat capacity:** energy required per unit mass of the substance to raise the temperature by 1 Kelvin

$$c = \frac{E}{m\Delta\theta}$$

Determining Specific Heat Capacity, c

- Quantities required:
 - Accurate measurement of mass
 - Temperature at time intervals
 - Voltage and current supplied

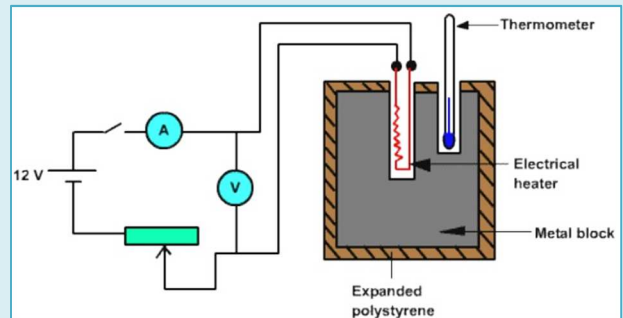

- Measure temperature at regular time intervals and plot graph of temperature θ against time t
- Divide quantity of heat equation with time

$$\frac{E}{\Delta t} = mc \left(\frac{\Delta\theta}{\Delta t} \right)$$

- $\frac{E}{\Delta t}$ is the power supplied P and $P = VI$
- $\frac{\Delta\theta}{\Delta t}$ is the gradient of the graph plotted

- Replacing quantities in original equation

$$VI = mc \times \text{gradient}$$

- Substitute values, rearrange and solve

- **Specific latent heat of sim:** energy required per unit mass of a substance to change from solid to liquid phase without any change in temperature
- **Specific latent heat of vaporization:** energy required per unit mass of a substance to change from liquid to gas phase without any change in temperature

$$l_{f/v} = \frac{E}{m}$$

- Specific latent heat of vaporization always greater than that of fusion for a given substance because:
 - During vaporization, greater increase in volume than in fusion; thus more work done against atmosphere
 - In vaporization, particles need to be separated further apart than in fusion so more work is done against forces of attraction when vaporizing

Determining Specific Heat Capacity, c

- Quantities required:
 - Mass at time intervals
 - Voltage and current supplied
- Beaker containing water heated to 100°C and maintained
- Mass readings taken at regular time intervals
- Plot graph of mass m against time t

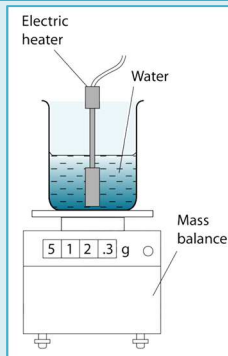

- If numerator and denominator in latent heat equation divided by time:

$$l_v = \frac{E/\Delta t}{\Delta m/\Delta t}$$

- $\frac{E}{\Delta t}$ is the power supplied P and $P = VI$
- $\frac{\Delta m}{\Delta t}$ is the gradient of the graph plotted (use +ve)
- Replacing quantities in original equation
 $l_v = \text{power} \div \text{gradient}$
- Substitute values, rearrange and solve

{S03-P04}

Question 2:

To harden a sample of pure gold, silver is mixed so that mixture contains 5.0% silver by weight. The initial temp. of the silver is 27 °C. Calculate the initial temp. of gold so that the final mixture is at the melting point of gold.

	gold	silver
melting point / K	1340	1240
specific heat capacity (solid or liquid) / J kg ⁻¹ K ⁻¹	129	235
specific latent heat of fusion / kJ kg ⁻¹	628	105

Solution:

As mass is not provided, we will consider a mixture of 100g with the mass of gold 95g and silver 5g. Firstly, calculate the energy required for silver to be at the m.p. of gold

$$Q = mc\Delta T$$

$$0.005 \times 235 \times (1340 - (273 + 27)) = 1222 \text{ J}$$

As silver is being heated past its m.p., it will also melt and change state ∴ energy required to change it from solid to liquid is required i.e. latent heat of fusion

$$Q = l_f \times m$$

$$105 \times 10^3 \times 0.005 = 525 \text{ J}$$

The quantity of energy gold should initially have must provide above calculated therefore

$$Q \text{ of Gold} = 1222 + 525$$

Gold will already be past its m.p. so no need to calculate heat of fusion, now using $mc\Delta T$

$$0.095 \times 129 \times \Delta T = 1747$$

$$\Delta T = 142.6$$

Initial temp. will obviously be above m.p. so adding to the final temp. of gold i.e. the m.p.

$$\text{Initial Temp. of Gold} = 1340 + 142.6 = 1483 \text{ K}$$

5.4 Internal Energy

- **Internal energy:** sum of random distribution of kinetic and potential energies of molecules in a system

$$\text{Internal Energy} = \text{Total P.E.} + \text{Total K.E.}$$

- A rise in temperature of a body is an increase in its internal energy

5.5 First Law of Thermodynamics

- **First law of thermodynamics:** the increase in internal energy of a system is equal to the sum of heat supplied to the system and the work done on the system

$$\Delta U = q + w$$

- ΔU : increase in internal energy of the system
- Q : heat supplied to the system
- W : work done on the system

{S04-P04}

Question 6:

Write down the symbol '+' for increase, the symbol '-' for decrease and the symbol '0' for no change,

	U	q	w
i) the compression of an ideal gas at constant temperature	0	-	+
ii) the heating of a solid with no expansion	+	+	0
iii) the melting of ice at 0 °C to give water at 0 °C (Note: ice is less dense than water)	+	+	0

Solution:

Part (i):

The gas is being compressed so work is being done on the system ($w = +$) and when a gas is compressed, its temperature rises. As the system is not providing heat, the gas itself is heating, ($q = -$). Overall, increase in work done is balanced by the gas heating so net remains 0 and internal energy unchanged ($U = 0$)

Part (ii):

The solid is being heated so ($q = +$). As the solid is not expanding, ($w = 0$) and therefore there is an increase in internal energy ($U = +$)

Part (iii):

The melting of ice requires heat energy provided so ($q = +$). No work is done on or by the system so ($w = 0$). Hence, there is a net increase so ($U = +$)

{S02-P04}

Question 2:

Some water in a saucepan is boiling.

a) Explain why:

i. external work is done by the boiling water

Volume increases due to evaporation (turns into a gas) hence work is done on pushing back the atmosphere.

ii. there is a change in the internal energy as water changes to steam

The E_k of atoms is constant as there is no temp. change but E_p changes because separation of atoms increases so internal energy increases because

$$\Delta U = E_p + E_K$$

b) By reference to the first law and your answer in (a), show that thermal energy must be supplied to the water during the boiling process

$$\Delta U = q + w$$

Changing from a liquid to a gas, there is an increase in internal energy. Work is done by the liquid so w is negative. For ΔU to be positive, q must increase.

- **Phase difference (ϕ):** measure of how much one wave is out of step with another wave

$$\phi = 2\pi \frac{t}{T}$$

where T is time period and t is time lag between waves

6.2 Simple Harmonic Motion

- **Simple harmonic motion:** acceleration proportional to displacement and directed towards a fixed point
- Requirements for SHM:
 - Mass that oscillates
 - Position where mass in equilibrium
 - Restoring force that acts to return mass to equilibrium; $F \propto -x$
- Defining equation of SHM:

$$a = -\omega^2 x$$

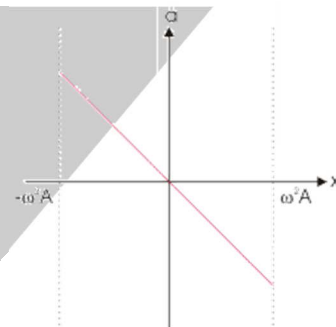

- The negative sign in the equation represents that a and x are in opposite directions. a is always directed towards the mean position.

6.3 Equations of SHM

Displacement:

$$x = x_0 \sin \omega t$$

$$x = x_0 \cos \omega t$$

(depending on initial conditions)

Velocity:

$$v = \pm \omega \sqrt{(x_0^2 - x^2)}$$

$$v = v_0 \cos \omega t$$

$$v = -v_0 \sin \omega t$$

(differential simplified because $x_0 \omega = v_0$)

- Maximum velocity at equilibrium position and minimum (0) at extremes

Acceleration:

$$a = -\omega^2 x$$

$$a = -\omega^2 (x_0 \sin \omega t)$$

$$a = -\omega^2 (x_0 \cos \omega t)$$

6. OSCILLATIONS

6.1 Describing Oscillations

- **Displacement (x):** instantaneous distance of the moving object from its mean position
- **Amplitude (A):** maximum displacement from the mean position
- **Period (T):** time taken for one complete oscillation
- **Frequency (f):** number of oscillations per unit time
- **Angular frequency (ω):** rate of change of angular displacement

$$\omega = 2\pi f$$

6.4 Graphs of SHM

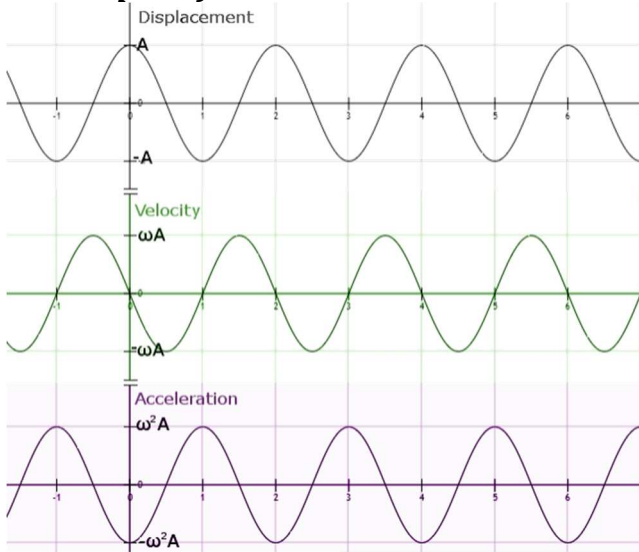

6.5 Energy in SHM

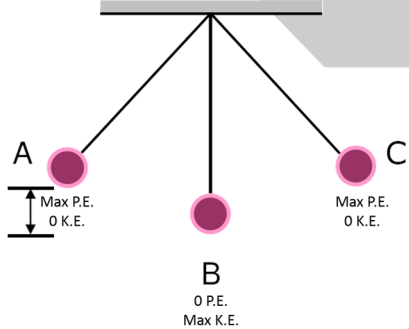

Kinetic Energy:

$$v = \pm \omega \sqrt{(x_0^2 - x^2)} \quad E_k = \frac{1}{2}mv^2$$

$$E_k = \frac{1}{2}m\omega^2(x_0^2 - x^2)$$

Total Energy:

At $x = 0$, E_k is max and = to total energy

$$E_k = \frac{1}{2}m\omega^2(x_0^2 - (0)^2)$$

$$\therefore E_{tot} = \frac{1}{2}m\omega^2x_0^2$$

Potential Energy:

$$E_{tot} = E_k + E_p \text{ so } E_p = E_{tot} - E_k$$

$$= \frac{1}{2}m\omega^2x_0^2 - \frac{1}{2}m\omega^2(x_0^2 - x^2)$$

$$E_p = \frac{1}{2}m\omega^2x^2$$

Graphs:

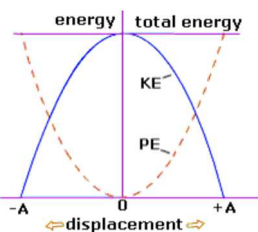

{W08-P04}

Question 3:

The needle of a sewing machine oscillates vertically through a total distance of 22 mm,

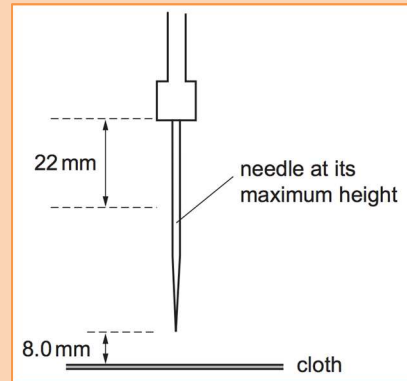

The oscillations are simple harmonic with a frequency of 4.5 Hz. The cloth being sewn is positioned 8.0 mm below the needle when it is at its maximum height. Calculate, for the point of the needle,

- its maximum speed
- its speed as it moves downwards through the cloth

Part (i):

Maximum speed can be calculated by

$$v_0 = \omega x_0$$

Firstly, we must find angular velocity

$$\omega = 2\pi f = 2 \times \pi \times 4.5 = 28.3 \text{ rad s}^{-1}$$

Next, we must find the amplitude. As the total vertical displacement is 22 mm,

$$x_0 = \frac{22}{2} = 11 \text{ mm}$$

Substitute data calculate into first expression

$$v_0 = 28.3 \times 11 \times 10^{-2} = 0.311 \text{ ms}^{-1}$$

Part (ii):

To find the velocity at that point, use the equation

$$v = \omega \sqrt{(x_0^2 - x^2)}$$

We need to find the displacement when the needle is passing through the cloth. From annotated diagram:

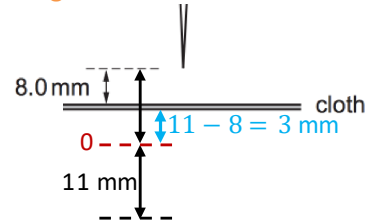

Hence, substitute values into equation and calculate v

$$v = 28.3 \times \sqrt{(11^2 - 3^2)} = 0.30 \text{ ms}^{-1}$$

6.6 Damping

- **Damping:** loss of energy and reduction in amplitude from an oscillating system caused by force acting in opposite direction to the motion (e.g. friction)
- **Light damping:** system oscillates about equilibrium position with decreasing amplitude over a period of time

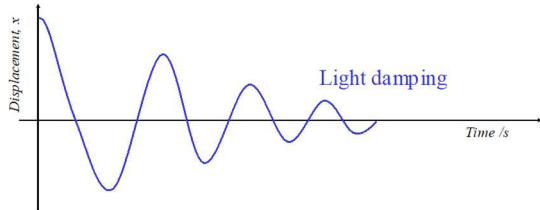

- **Critical damping:** system does not oscillate & is amount of damping required such that the system returns to its equilibrium position in the shortest possible time
- **Heavy damping:** damping is so great that the displaced object never oscillates but returns to its equilibrium position very very slowly

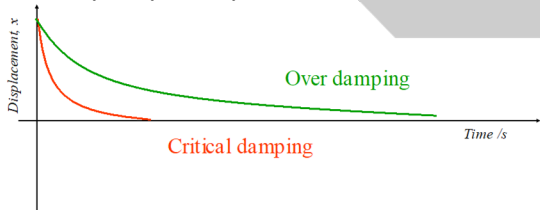

6.7 Practical Examples of Damping

	Oscillation	Damping
Car suspension	Car oscillates due to spring like connection to wheels	Critical damping needed to stop oscillation as quickly as possible to avoid motion sickness – hydraulic in nature
Tall buildings	During earthquakes	Large weight hung at the top of the building to supply a counter oscillation

6.8 Natural Frequency and Resonance

- **Natural frequency f_0 :** the unforced frequency of oscillation of a freely oscillating object
- **Free oscillation:** oscillatory motion not subjected to an external periodic driving force; oscillates at natural freq. Eg : Tuning fork, Pendulum
- **Forced oscillation:** oscillation caused by an external driving force; frequency is determined by driving force

- **Resonance:** the maximum amplitude of vibration when impressed frequency equals natural frequency of vibration

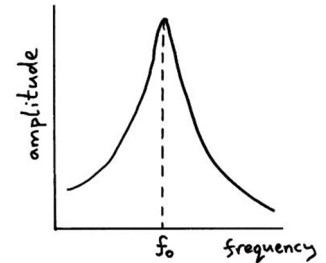

6.9 Damping and Resonance

- Effects of damping on frequency response of a system undergoing forced oscillations:
 - Decreases amplitude at all frequencies
 - Slightly decreases resonant frequency
 - Resonant peak becomes flatter

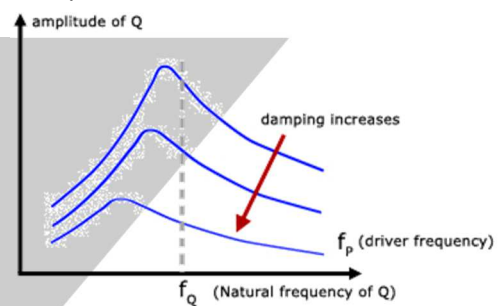

6.10 Purposes of Resonance

Examples of Useful Purposes of Resonance:

- Oscillation of a child's swing
- Tuning of radio receiver - natural frequency of radio is adjusted so that it responds resonantly to a specific broadcast frequency
- Using microwave to cook food - produces microwaves of frequency equal to natural frequency of water, causing the water molecules in food to vibrate generating heat
- Magnetic Resonance Imaging (MRI) is used in hospitals to create images of the human organs

Examples of Destructive Nature of Resonance:

- High-pitched sound waves can shatter fragile objects e.g. shattering of a glass when a soprano hits a high note
- Buildings that vibrate at natural frequencies close to the frequency of seismic waves collapse during earthquakes
- A car suspension system vibrates when going over bumps which would give large amplitude vibrations

7. ELECTRIC FIELDS

- The **electric field of a charge** is the space around the charge in which an electric force due to that charge is experienced

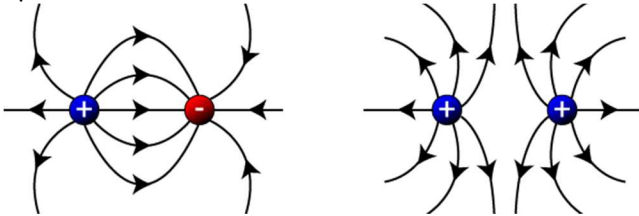

- Direction of field lines show the direction of the field – always from the positive charge to the negative
- Higher density of lines shows a stronger region of field

7.1 Coulomb's Law

- Any two point charges exert an electrical force on each other that is proportional to the product of the charges and inversely proportional to the square of separation

$$F \propto \frac{Qq}{r^2}$$

$$F = \frac{Qq}{4\pi\epsilon_0 r^2}$$

7.2 Electric Field of a Point Charge

- Electric field strength:** force per unit positive charge
- Dividing force by charge q :

$$E = \frac{Q}{4\pi\epsilon_0 r^2}$$

7.3 Electric Potential

- Electric potential** at a point is the work done in bringing unit positive charge from infinity to that point

$$W = VQ \text{ and } W = F \cdot d$$

$$V = \frac{F \cdot d}{Q}$$

$$V = \frac{Q}{4\pi\epsilon_0 r}$$

- The **potential difference** between two points A and B from an isolated charge Q is defined as work done in taking a unit positive charge from B to A

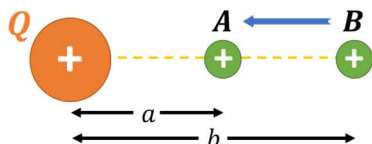

$$V_{AB} = \frac{Q}{4\pi\epsilon_0} \left(\frac{1}{b} - \frac{1}{a} \right)$$

- V_{AB} is equal to the gain in electrical potential energy if Q is positive and loss if Q is negative

In general,

- If +ve charge moved in direction of electric field, its electric potential energy will decrease
- If -ve charge moved in direction of electric field, its electric potential energy will increase
- If charge accelerated in the field, its electrical potential energy will be converted to kinetic $\therefore Vq = \frac{1}{2}mv^2$

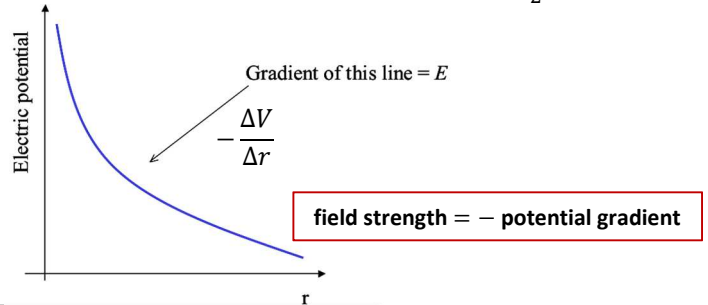

{S06-P04}

Question 2:

The maximum field strength at the surface of the sphere before electrical breakdown (sparking) occurs is $2.0 \times 10^6 \text{ Vm}^{-1}$. The sphere has a radius r of 0.35m.

Calculate the maximum values of

- the charge that can be stored on the sphere
- the potential at the surface of the sphere

Solution:

Part (a):

Max field strength given so using field strength formula

$$E = \frac{Q}{4\pi\epsilon_0 r^2}$$

Substitute information given

$$2 \times 10^6 = \frac{1}{4\pi\epsilon_0} \times \frac{Q}{0.35^2}$$

$$Q = 2.7 \times 10^{-5} \text{ C}$$

Part (b):

Using charge calculate in potential equation

$$V = \frac{Q}{4\pi\epsilon_0 r}$$

Substitute information given

$$V = \frac{1}{4\pi\epsilon_0} \times \frac{2.6 \times 10^{-5}}{0.35}$$

$$V = 7.0 \times 10^5 \text{ V}$$

7.4 Potential Due to a Conducting Sphere

- A charge $+Q$ on an isolated conducting sphere is uniformly distributed over its surface
- Charge remains on surface and at all points inside the sphere, the field strength is 0

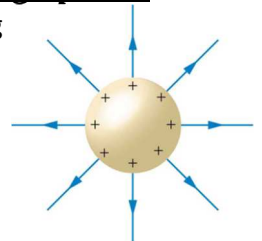

- As there is no field inside the sphere, the potential difference from any point inside the sphere to the surface is zero. Therefore, the potential at any point inside a charged hollow sphere is the same as its surface

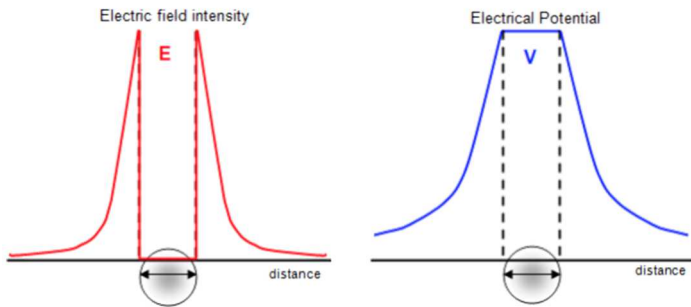

7.5 Equipotential

- Equipotential surface:** a surface where the electric potential is constant
- Equipotential lines are drawn such that potential is constant between intervals
- As potential constant, the potential gradient = 0, hence E along surface = 0
- Hence no work is done when a charge is moved along this surface

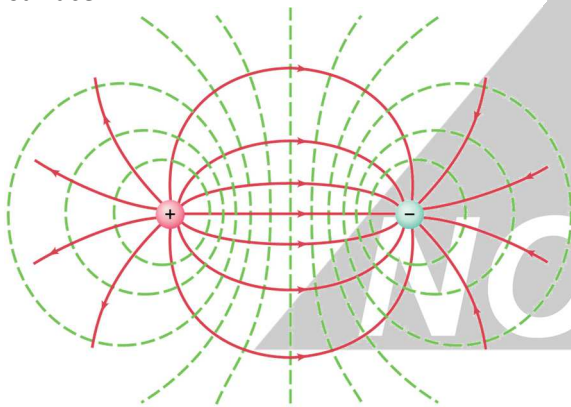

- Electric field lines must meet equipotential surface at **right angles**
- Spacing will be closer when field is stronger

7.6 Similarity & Differences between Electric and Gravitational Potential

- Similarities:**
 - Ratio of work done to mass/charge
 - Work done moving unit mass/charge from infinity
 - Both have zero potential at infinity
- Differences:**
 - Gravitational forces are always attractive
 - Electric forces can be attractive or repulsive
 - For gravitational, work got out as masses come together
 - For electric, work done on charges if same sign, work got out if opposite sign as charges come together

8. CAPACITANCE

8.1 Capacitors

- Function:** storing energy
- Usage:** Time delay, power smoothing and protection against surges and spikes

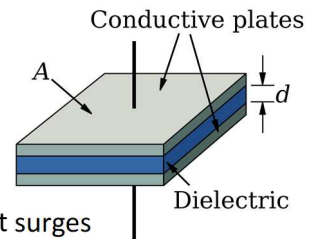

- Dielectric:** an electrical insulator

How a Capacitor Stores Energy:

- On a capacitor, there is a separation of charge with +ve on one plate and -ve on the other.
- To separate the charges, work must be done hence energy is released when charges come together

8.2 Capacitance and Farad

- Capacitance:** the ratio of charge stored by a capacitor to the potential difference across it
- Farad (F):** Unit of capacitance, 1 coulomb per volt.

$$C = \frac{Q}{V}$$

- The capacitance of a capacitor is directly proportional to the area of the plates and inversely proportional to the distance between the plates

8.3 Dielectric Breakdown

An electric field can cause air to become conducting by:

- The electric field causes forces in opposite directions on the electrons and nucleus of atoms in air
- This results in the field causing electrons to be stripped off the atom.
- Results in a spark – air now contains oppositely charged particles which can carry charge.

8.4 Capacitors in Parallel

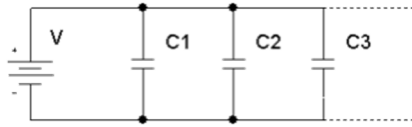

By conservation of energy and hence charge ($W = QV$), the total charge in a circuit is sum of individual charges

$$Q_T = Q_1 + Q_2 + Q_3$$

Apply $Q = CV$ and V constant in parallel

$$Q_T = V(C_1 + C_2 + C_3)$$

$$\frac{Q_T}{V} = C_1 + C_2 + C_3$$

Hence,

$$C_T = C_1 + C_2 + C_3$$

8.5 Capacitors in Series

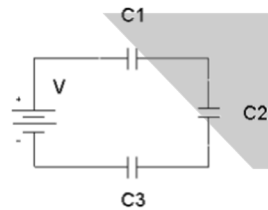

Total p.d. in a circuit is sum of individual p.d.

$$V_T = V_1 + V_2 + V_3$$

Apply $Q = CV$ and Q constant in series

$$V_T = Q \left(\frac{1}{C_1} + \frac{1}{C_2} + \frac{1}{C_3} \right)$$

$$\frac{V_T}{Q} = \frac{1}{C_1} + \frac{1}{C_2} + \frac{1}{C_3}$$

Hence,

$$\frac{1}{C_T} = \frac{1}{C_1} + \frac{1}{C_2} + \frac{1}{C_3}$$

8.6 Capacitance of a Body

- Any isolated body can have a capacitance.
- Considering a sphere of radius r carrying charge Q , the potential at surface is

$$V = \frac{Q}{4\pi\epsilon_0 r}$$

$$C = \frac{Q}{V} = \frac{Q}{Q/4\pi\epsilon_0 r} = 4\pi\epsilon_0 r$$

{W09-P42}

Question 4:

An isolated metal sphere of radius 63cm is charged to a potential of 1.2×10^6 V. At this potential, there is an electrical discharge in which it loses 75% of its energy.

- Calculate the capacitance of the sphere
- Calculate the potential of the sphere after the discharge has taken place.

Solution:

Part (a):

Using equation derived above

$$C = 4\pi \times 8.85 \times 10^{-12} \times 63 \times 10^{-2} \\ = 7.0 \times 10^{-11} \text{ Farad}$$

Part (b):

Using equation for energy

$$W = CV^2$$

After the discharge, the sphere contains 25% of the energy before so equating energy before and after

$$25\% \times C \times (1.2 \times 10^6)^2 = CV^2$$

Cancel the C and calculate V

$$V = 6.0 \times 10^5 \text{ V}$$

8.7 Energy Stored in a Capacitor

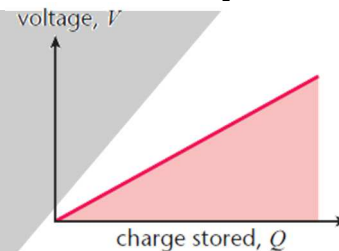

- Area under a potential-charge graph is equal to work done

$$W = \frac{1}{2} QV = \frac{1}{2} CV^2$$

- The half comes in because:
 - When the first charge flows onto the capacitor plates there is no potential difference opposing the flow
 - As more charge flows, the potential difference increases, so more work is done
 - The average potential difference is equal to half the maximum potential difference

9. MAGNETIC FIELDS

9.1 Concept of Magnetic Field

- Magnetic field:** a region in which a magnet, a wire carrying current or a moving charge experiences a force
- Can be produced by
 - Current-carrying conductor
 - Permanent magnets

9.2 Representing Magnetic Fields

Magnetic Field due to Permanent Magnet

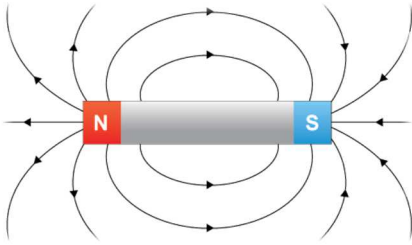

- Magnetic field lines come out of the north pole and go into the south pole
- Direction of field line at any point in the field shows the direction of the force that a 'free' magnetic north pole would experience
- Field is strongest where field lines are closest together

9.3 Electromagnetism

Strength of magnetic field can be increased by:

- Increasing the current
- Increasing number of turns per unit length of solenoid
- Using soft-iron core within solenoid

Right Hand Grip Rule:

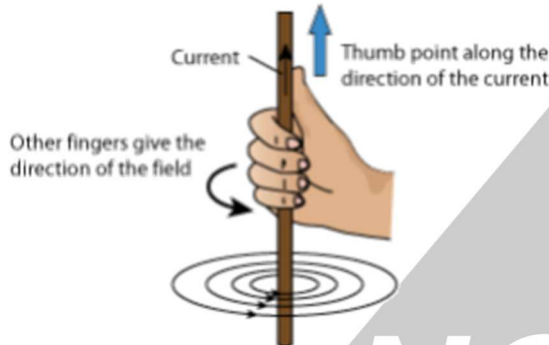

- **For a long, straight conductor:**
 - Magnetic field lines are concentric circles centered at the conductor
 - Separation between adjacent field lines increases with distance from the conductor
 - Magnetic field is non-uniform

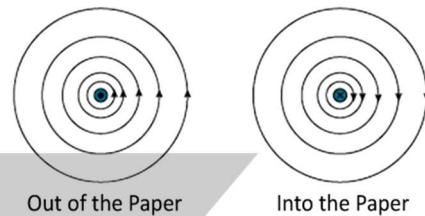
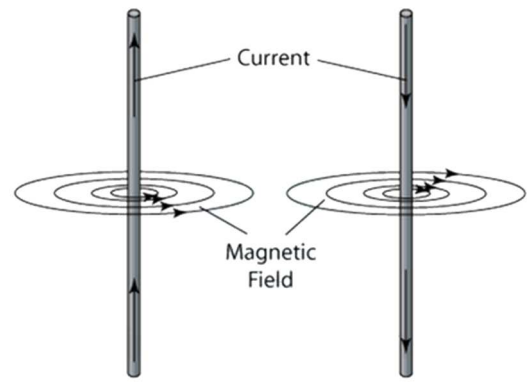

- **For a flat, circular coil:**

- Magnetic field pattern produced represents that produced by a short bar magnet

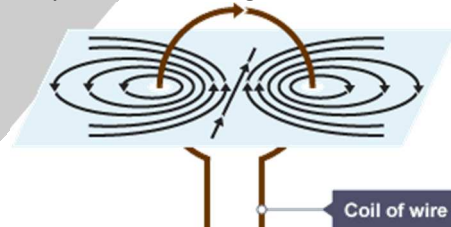

- **For a solenoid and flat, circular coil:**

- Magnetic field pattern produced identical to that produced by a bar magnet
- Magnetic field lines within solenoid are parallel indicating strength is same (uniform field)

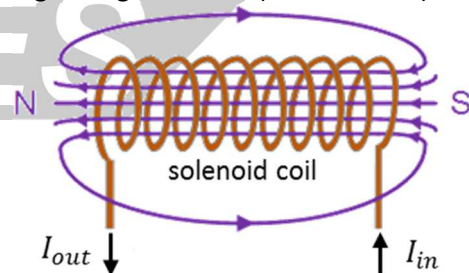

9.4 Determining Pole of Magnetic Field

- Determined by Right Hand Grip rule however this time, fingers represent current

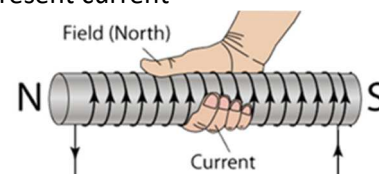

9.5 Effect of Ferrous Core in Solenoid

- The strength of the generated magnetic field can be increased (by about 1000 times) by adding a ferrous (iron) core inside the solenoid.

Two possible reasons to explain this effect

- Ferrous material has a higher permeability than air; stronger ability to support the formation of a magnetic field within itself
- Ferrous material are magnetic and become magnetized when placed into the solenoid, thus contributing to overall magnetic field strength of the solenoid.

9.6 Force on a Current-Carrying Conductor

Fleming's Left Hand Rule

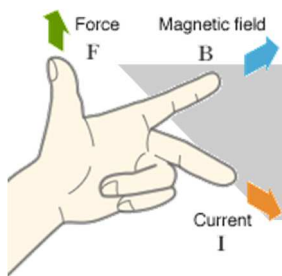

Force Acting on a Current-carrying Conductor in a Magnetic Field

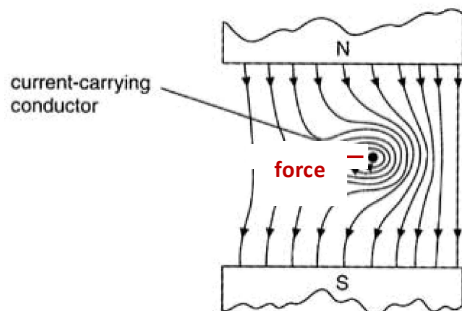

- Strength of force can be increased by:
 - Increasing the current
 - Using a stronger magnet

9.7 Forces between Currents

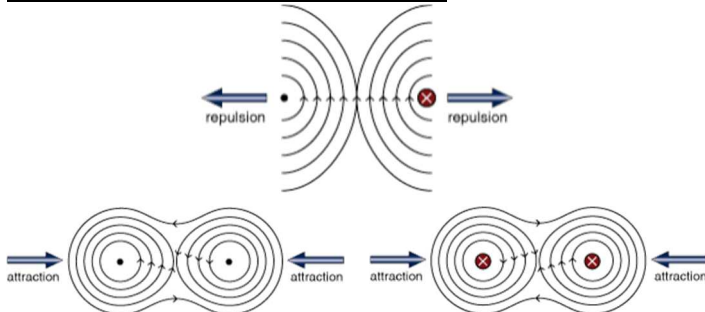

- Can be worked out by considering one wire's magnetic field (using Right Hand Grip rule), drawing a tangent at the position of the the other wire and then applying Fleming's Left Hand Rule

9.8 Magnetic Flux Density

- Magnetic flux (Φ):** number of magnetic field lines passing normally to a given area. Unit = weber (Wb)
- Magnetic flux density (B):** force acting per unit current on unit length of conductor placed at right angles to the magnetic field

$$\Phi = BA$$

- 1 Tesla** is the magnetic field producing a force of 1 N m^{-1} on a wire carrying current of 1 A normal to the field

$$1\text{T} = 1 \text{ N A}^{-1} \text{ m}^{-1}$$

- The magnitude of the force on a current-carrying conductor with:**

$$F = BIL \sin \theta$$

- Find direction using Fleming's Left Hand Rule
- If wire parallel to the field lines, $\theta = 0$ and $F = 0$
- If the wire is at right angles to field lines, $\theta = 90$ and force acting on wire maximum ($F = BIL$)

{W09-P42}

Question 5:

Two long straight vertical wires X and Y pass through a horizontal card, carrying current upward. The magnetic flux density B at a distance x from a long straight wire due to a current I in the wire is given by

$$B = \frac{\mu_0 I}{2\pi x}$$

The current in wire X is 5.0 A and that in wire Y is 7.0 A . The separation of the wires is 2.5 cm

- Calculate the force per unit length on wire Y due to the current in wire X
- The currents in the wires are not equal. State and explain whether the forces on the two wires are equal in magnitude

Solution:

Part (a):

Using given expression, find B due to wire X by substituting current in X and separation

$$B = \frac{4\pi \times 10^{-7} \times 5}{2\pi \times 2.5 \times 10^{-2}} = 4 \times 10^{-5}$$

To find force per unit length, divide expression for force by length and substitute values – calculated B from above and current in Y

$$F = BIl \div l = BI$$

$$\frac{F}{l} = 4 \times 10^{-5} \times 7 = 2.8 \times 10^{-4}$$

Part (b):

The force due to the magnetic field depends on the product of the currents in the two wires hence both values would be equal. Also, Newton's 3rd law applied and the reaction force is equal but opposite.

9.9 Measuring Flux Density

- The force on a current-carrying conductor can be used to measure the flux density of a magnetic field using a current balance

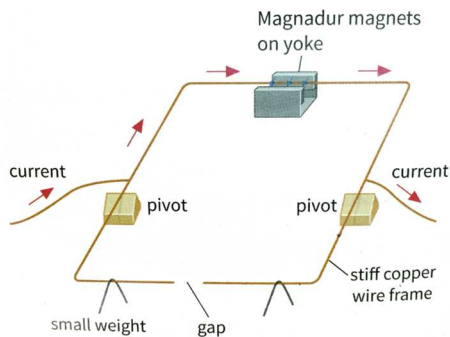

Small weights = mg Force due to current = Bil
 Assuming forces act at same distance from pivot, so no need to take moments, equate forces

$$mg = Bil$$

$$B = \frac{mg}{il}$$

9.10 Force on a Moving Charge

$$F = Bil \quad \text{and} \quad I = \frac{Q}{t}$$

$$\therefore F = Bq\left(\frac{l}{t}\right) \quad \text{and} \quad v = \frac{l}{t}$$

$$\therefore F = BQv$$

- If particle moving at an angle θ to the magnetic field, the component of velocity \perp to magnetic field is $v \sin \theta$

9.11 The Hall Effect

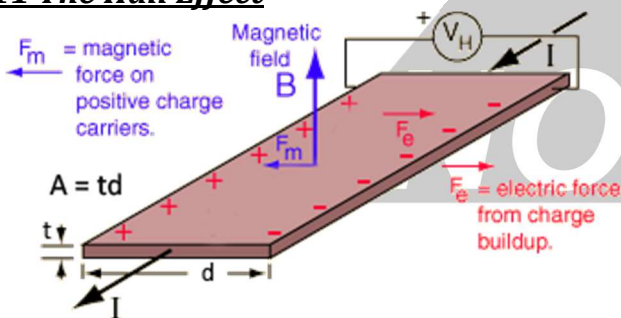

- The Hall effect is a mechanism in which magnetic and electric forces on a moving charged particle are balanced
- The probe is made of semiconductor material as electrons travel faster in it than metal \therefore greater effect
- A small current flows through the probe and a magnetic field is applied so the electrons are pushed sideways by the magnetic force, accumulating on one side hence producing a small voltage; Hall voltage
- The greater the flux density, greater the Hall voltage
- If magnetic field direction is reversed, electrons pushed to opposite side and Hall voltage is reversed

9.12 The Hall Voltage

- An electric field is set up in the probe as there is a difference in voltage between a distance d so

$$E = \frac{V_H}{d}$$

- As a single electron travels with drift velocity v , it experiences a force to the left due to the magnetic field Bqv and a force to the right due to the electric field Eq
- Soon an equilibrium is reached hence forces equated

$$Eq = Bqv$$

- Substitute for E

$$\frac{qV_H}{d} = Bqv$$

- Current is related to mean drift velocity by

$$I = nAvq$$

where $A = td$ is cross sectional area and n is number density of conducting particles

- Substitute for v and rearrange

$$\frac{qV_H}{d} = \frac{BqI}{n(td)q}$$

$$V_H = \frac{BI}{ntq}$$

9.13 Deflection of e^- through B-Field

Circular motion

- Circular path
- E_k constant

$$BQv = \frac{mv^2}{r} \quad \text{so} \quad r = \frac{mv}{BQ}$$

- Faster moving particles move in bigger circles, $r \propto v$
- Heavier particle move in bigger circles, $r \propto m$
- Stronger field, particle moves in smaller circle, $r \propto \frac{1}{B}$

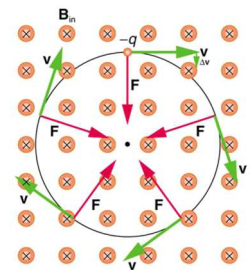

9.14 Charge-to-Mass Ratio

- The charge-to-mass ratio is known as the specific charge on the electron

Determination of $\frac{e}{m_e}$:

- Work done by electron is equivalent to E_k it possesses

$$W = QV \quad E_k = \frac{1}{2}mv^2$$

$$eV = \frac{1}{2}m_e v^2$$

- Using equation for an electron travelling in a circle in a magnetic field to eliminate v

$$v = \frac{rBe}{m_e}$$

$$eV = \frac{1}{2}m_e \left(\frac{rBe}{m_e}\right)^2$$

$$\frac{e}{m_e} = \frac{2V}{r^2 B^2}$$

9.15 Deflection of e^- through E-Field

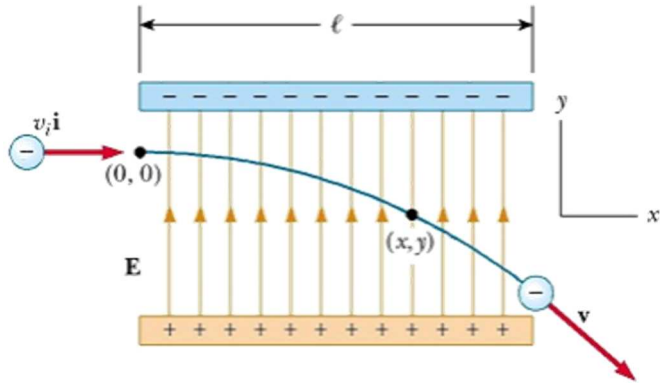

Determining the motion of the electron:

$$s = ut + \frac{1}{2}at^2 \text{ and initial vertical velocity} = 0 \text{ ms}^{-1}$$

$$y = \frac{1}{2}at^2$$

Finding an equation for acceleration

$$F = qE$$

and

$$F = ma$$

$$\therefore a = \frac{eE}{m}$$

As particle moving horizontally at constant velocity and time is the same for the whole journey

$$x = vt$$

$$t = \frac{x}{v}$$

$$y = \left(\frac{eE}{2mv^2} \right) \cdot x^2$$

- Hence, $y \propto x^2$ therefore parabolic (projectile) motion
- Gain in y -component of velocity $\therefore E_k$ increases

9.16 Crossed-Fields

- Considering a setup where electric and magnetic field are perpendicular to each other and act on a moving charge simultaneously
- In such case, a certain velocity exists where fields exert equal and opposite forces.

$$B\text{-Field} = E\text{-Field}$$

$$BQv = QE$$

$$v = \frac{E}{B}$$

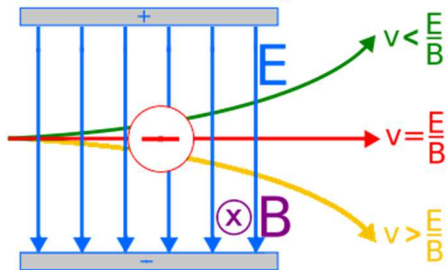

- If velocity higher, $F = BQv$ hence magnetic force stronger & effect of force due to electric field decreases
- If velocity lower, $F = BQv$ hence magnetic force weaker & effect of force due to electric field increases

9.17 Force in Gravitational, Electric and Magnetic Fields

Gravitational	Electric	Magnetic
Force always attractive	Forces is attractive or repulsive	
Force directly proportional to the mass	Force directly proportional to the charge	Force directly proportional to the current
Force inversely proportional to square of the distance		
Force independent of the medium	Force depends on the medium	
Force is weak	Force is strong	
Force is in direction of field	Force is parallel to the field	Force is perp. to the field
Force independent of state of motion of the body		Force directly proportional to velocity of body

{W09-P04}

Question 8:

A small mass is placed in a field of force that is either electric or magnetic or gravitational.

State the nature of the field of force when the mass is

i. charged & force is opposite to direction of the field,

Electric field

ii. uncharged and force is in the direction of the field

Gravitational field

iii. charged & there is a force only when mass is moving

Magnetic field

iv. charged and there is no force on the mass when it is stationary or moving in a particular direction

Magnetic field

10. ELECTROMAGNETIC INDUCTION

10.1 Inducing e.m.f

- EM induction is an action-at-a-distance phenomenon
- e.m.f. is induced when magnetic flux linking a conductor changes either by
 - no. of lines linking B-field changes
 - no. of field lines being cut change

e.g. moving coil from A to B

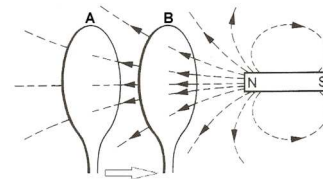

- no. of lines linked increases from 3 to 5
- no. of lines cut increases from 0 to 2
- Hence an e.m.f. is induced

10.2 Magnetic Flux Linkage

- **Magnetic flux:** product of magnetic flux density and area normal to the field through which the field is passing.

$$\phi = BA$$

- **1 Weber (Wb)** is the flux that passes through an area of 1m² when the magnetic flux density is 1 tesla.

$$1 \text{ Wb} = 1 \text{ T m}^2$$

- **Magnetic flux linkage:** product of magnetic flux and number of turns

$$\text{Magnetic flux linkage} = N\phi$$

- Factors affecting magnitude of induced e.m.f.

- Magnetic field density, B
- Speed of motion of magnet, v
- Number of turns of coil, N

10.3 Faraday's and Lenz's Law

- **Faraday's Law:** the **magnitude** of induced e.m.f is proportional to rate of change of magnetic flux-linkage

$$V = \frac{dN\phi}{dt}$$

- **Lenz's Law:** the **direction** of the induced e.m.f. is such that it tends to oppose the flux change causing it

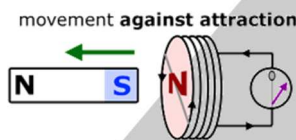
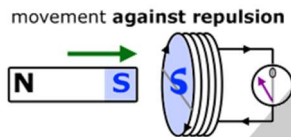

$$V = \frac{-dN\phi}{dt}$$

{S11-P42}

Question 5:

Use Faraday's Law to explain why

- there is a reading on the voltmeter
Moving magnet causes a change of flux linkage
- this reading varies in magnitude
Speed of magnet varies so varying rate of change of flux
- the reading has both positive and negative values
Magnet changes direction of motion

Fleming's Right Hand Rule:

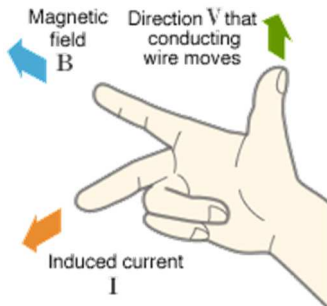

{S08-P04}

Question 6:

A small rectangular coil ABCD contains 140 turns of wire

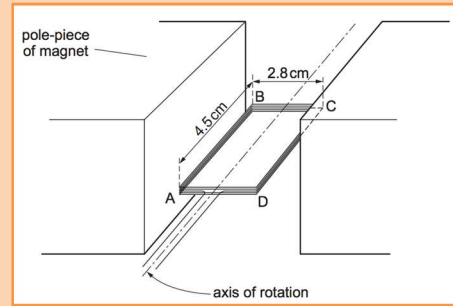

The coil is held between the poles of a large magnet so that the coil can rotate about an axis through its centre. When the current in the coil is 170 mA, the maximum torque produced in the coil is $2.1 \times 10^{-3} \text{ N m}$.

- What position to the magnetic field should the coil be in for maximum torque
- For the coil in position shown, calculate the magnitude of the force on side AB
- Show that the magnetic flux density (B) is 70 mT
- The current in the coil is switched off and the coil is turned through an angle of 90° in a time of 0.14 s. Calculate the average e.m.f induced.

Solution:

Part (a):

Maximum torque when parallel. When normal to the plane, there is no perpendicular distance between the two forces \therefore minimum/0 torque.

Part (b):

$$\text{Torque} = \text{Force} \times \perp \text{Distance between Forces}$$

$$2.1 \times 10^{-3} = 2.8 \times 10^{-2} \times x$$

$$x = 0.075 \text{ N}$$

Part (c):

$$F = BIl$$

Using force calculated previously, and information from question

$$0.075 = B \times 170 \times 10^{-3} \times 4.5 \times 10^{-2}$$

$$B = 9.80 \text{ T}$$

Value calculated is for 140 turns so dividing by it

$$\frac{9.80}{140} = 0.0700 \text{ T} = 70 \text{ mT}$$

Part (d):

Firstly, calculate ϕ from B calculate above

$$\phi = BA$$

$$\phi = 70 \times 10^{-3} \times (2.8 \times 10^{-2}) \times (4.5 \times 10^{-2})$$

$$\phi = 8.82 \times 10^{-5} \text{ Wb}$$

Using Faraday's law:

$$V = \frac{dN\phi}{dt}$$

Substituting information given and ϕ calculated

$$V = \frac{140 \times 8.82 \times 10^{-5}}{0.14} = 0.0882 \text{ V}$$

11. ALTERNATING CURRENTS

11.1 Sinusoidal Current

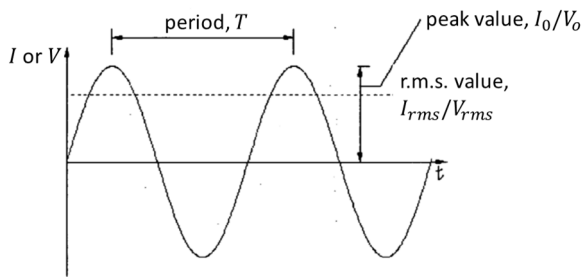

- **Period, T** : the time for one complete cycle of the a.c.
- **Frequency, f** : number of oscillations per unit time

$$f = \frac{1}{T}$$

- **Peak value, I_0/V_0** : highest point on the graph

- **Instantaneous current/voltage, I/V** : the current/voltage at a particular instant

$$I = I_0 \sin \omega t \qquad V = V_0 \sin \omega t$$

where $\omega = 2\pi f$

- The **root-mean-squared (r.m.s.) value, I_{rms}/V_{rms}** is the value of steady current/voltage that produces same power in a resistor as the alternating current/voltage

$$I_{rms} = \frac{I_0}{\sqrt{2}} \qquad V_{rms} = \frac{V_0}{\sqrt{2}}$$

11.2 Mean Power in an a.c. Supply

- For a sinusoidal alternating current, peak power is twice the average power

$$P = IV \text{ and using } I_{rms} \text{ and } V_{rms}$$

$$P = \frac{I_0}{\sqrt{2}} \times \frac{V_0}{\sqrt{2}} = \frac{1}{2} IV$$

{S10-P42}

Question 7:

An alternating voltage is represented by the equation

$$V = 220 \sin(120\pi t)$$

For this alternating voltage, determine

- peak voltage
- the r.m.s voltage
- the frequency

Solution:

Part (a):

Simply using the equation, $V = 220 \text{ V}$

Part (b):

$$V_{rms} = \frac{V_0}{\sqrt{2}} = \frac{220}{\sqrt{2}} = 156 \text{ V}$$

Part (c):

The quantity in $\sin()$ is equal to $\omega t \therefore$

$$\omega = 120\pi$$

Also, $\omega = 2\pi f$ so

$$f = \frac{120\pi}{2\pi} = 60 \text{ Hz}$$

11.3 Transformer

- **Transformer**: device used to increase or decrease the current or voltage of an alternating current
- **Ideal transformer**: no power loss in the transformer

$$\text{Input Power} = \text{Output Power}$$

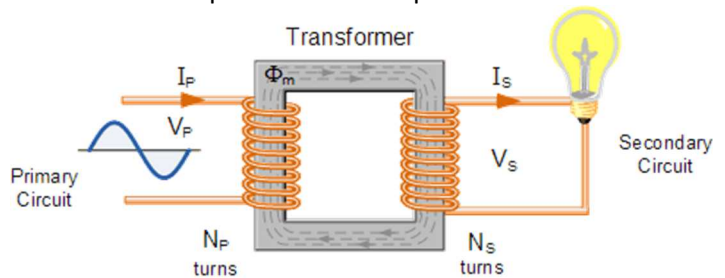

- The p.d. V_P across the primary coil causes an alternating current I_P to flow, producing a magnetic field in the soft iron core
- The secondary coil is thus in a changing magnetic field, and an alternating current I_S is induced in it, producing an alternating e.m.f. V_S across the secondary coil
- **Step-up transformer**: primary coil has fewer turns than secondary coil hence output voltage greater (current decreases by the same factor)
- **Step-down transformer**: primary coil has greater turns than secondary coil hence output voltage lower (current increases by the same factor)

Transformer relationships:

$$\begin{aligned} I_P V_P &= I_S V_S \\ \frac{N_S}{N_P} &= \frac{V_S}{V_P} = \frac{I_P}{I_S} \end{aligned}$$

(or simply use ratios)

11.4 Phase Difference in V_P/V_S and $I_P/I_S/\phi$

The alternating current in the primary coil is not in phase with the alternating e.m.f induced in the secondary coil:

- Current in primary coil gives rise to magnetic field
- The magnetic field in the core is in phase with current in the primary coil
- The magnetic flux cuts the secondary coil inducing e.m.f. in the secondary coil
- The e.m.f. induced proportional to rate of change of field so not in phase

V_P and V_S have a phase difference of 90° with I_S , I_P and ϕ

11.5 Eddy Currents

- If a metallic conductor moves in a magnetic field, an e.m.f is induced which will make free e⁻s in the metal move, causing electric current – eddy currents
- The eddy currents will oppose change in flux linkage of the conductor by Lenz's law and energy of motion will be dissipated as heat.

11.6 Energy Loss in a Practical Transformer

- Some power is lost due to resistance in the coils of transformers causing them to heat up
- Some power is lost as the magnetic flux flows back and forth. To minimize this, a soft magnetic material is used where magnetic flux direction can change easily
- Losses also occur in the core due to eddy currents: induced currents flow through the iron core & dissipate energy due to its resistance. Currents can be reduced by making core out of thin laminated sheets; flux can easily flow but eddy currents cannot.

11.7 Transmission of Electrical Energy

- Electricity transmission lines have resistance, therefore, energy will be lost through heating in the wires

Electricity transmitted at high voltage a.c. supply:

- **High voltage:** for same power, current is smaller so less heating and voltage loss in cables/wires
- **a.c. supply:** can change output voltage efficiently using transformers

11.8 Half-Wave Rectification

- For one-half of the time, the voltage is 0; this means that the power available from a half-wave rectified supply is reduced.

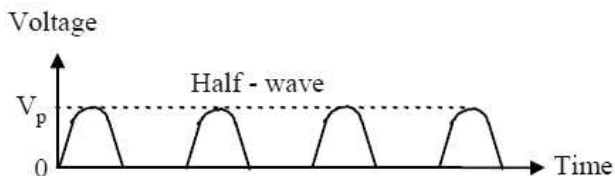
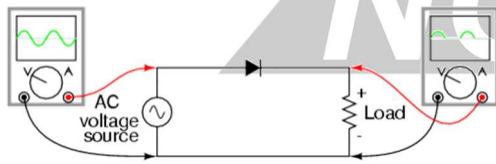

11.9 Full-Wave Rectification

- The four diodes are known as a bridge diode
- When current flowing for first half of period

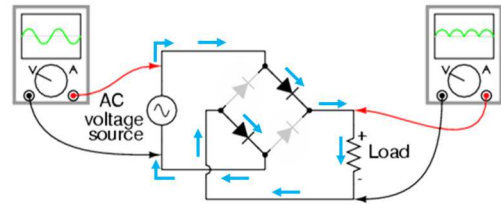

- When current flowing for second half of period

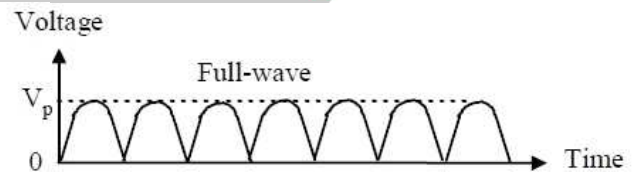
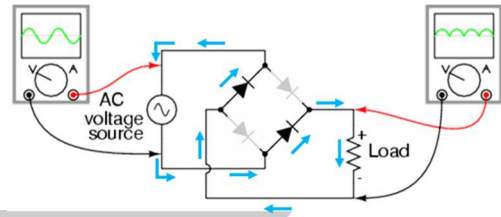

11.10 Smoothing

- In order to produce steady d.c. from 'bumpy' d.c. that results from rectification requires a smoothing capacitor
- The capacitor charges and maintains the voltage as a.c. voltage rises, (first half of the wave).
- As the wave slopes downward, the capacitor begins to discharge in order to maintain the voltage

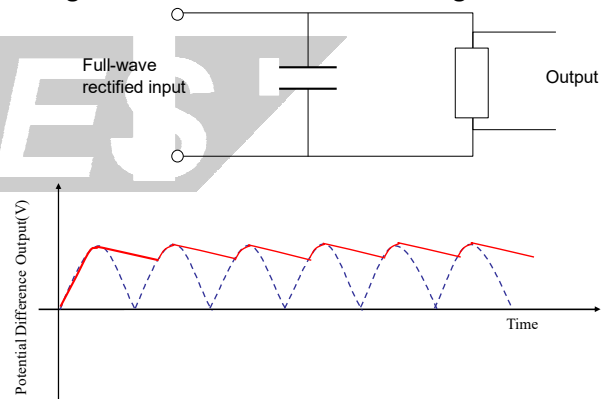

- A small capacitor discharges more rapidly than a large capacitor and gives rise to a greater ripple in output
- If the load resistor is small, the capacitor will also discharge rapidly
- CR is the time constant of a capacitor resistor: time taken for charge to fall $\frac{1}{e}$ times original value

- Value should be much greater than the time period of a.c. supply so capacitor does not have sufficient time to discharge significantly
- In general, the greater the value $R \times C$, the smoother the rectified a.c.

12. QUANTUM PHYSICS

12.1 Wave and Particle Model

- **Particle model:** objects that are hard, have mass and move about according to laws of Newtonian mechanics
- **Wave model:** shaped like a sine graph, do not have mass or charge. Their defining characteristics are diffraction and interference

12.2 Photoelectric Effect

- **Photoelectric effect:** when an electromagnetic radiation of sufficiently high frequency falls on a metal surface, electrons are emitted
- Delocalized electrons in metal are removed by supplying a small amount of energy provided by the incident electromagnetic radiation
- Emitted electrons are called **photoelectrons**
- **Photoelectric current:** current due to photoelectrons

12.3 Demonstrating Photoelectric Effect

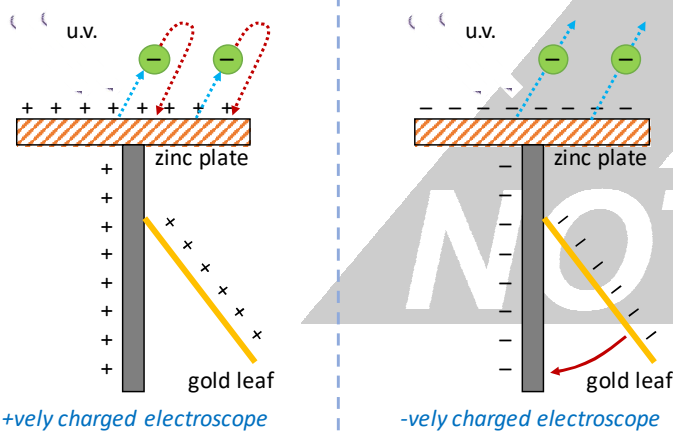

- **+vely charged:** when zinc plate exposed to u.v., the leaf remains open because though electrons are emitted, they are attracted back due to +ve charge on zinc plate
- **-vely charged:** when zinc plate exposed to u.v., the leaf slowly collapses as electrons are emitted hence -ve charge on electroscope decreases

Laws of Photoelectric Emission:

- **1st Law:** number of photoelectrons emitted per second is directly proportional to intensity of incident radiation
- **2nd Law:** max kinetic energy of photoelectrons is directly proportional to the frequency of the incident radiation but independent of its intensity
- **3rd Law:** for every metal, there is a minimum frequency of incident radiation below which photoelectric emission does not take place; threshold frequency
- **Threshold frequency:** minimum frequency required to release electrons from the surface of a metal

12.4 Particulate Nature of Electromagnetic Radiation

- Energy of an electromagnetic wave doesn't flow continuously but in discrete quanta
- **Photon:** each quantum (particle) of electromagnetic radiation
- Energy of a photon of an electromagnetic radiation of frequency f is given by

$$E = hf$$

where h is the Planck's constant = 6.63×10^{-34} Js

- **Work function (Φ):** minimum amount of energy required by an electron to escape its surface
- For a given frequency, electrons are emitted with a range of k.e. because electrons deeper inside the metal lose energy in collision with atoms as they are emitted

12.5 Einstein's Photoelectric Equation

$$hf = \phi_0 + E_{max}$$

where ϕ_0 is the work function of the metal

- Thus, the energy of the absorbed photon is partly used to release the electron from the metal and partly to give it a kinetic energy

$$hf = hf_0 + \frac{1}{2}mv_{max}^2$$

where f_0 is the threshold frequency

12.6 Wave-Particle Duality

- **Wave behavior:** electromagnetic radiation shows properties of diffraction and interference
- **Particle behavior:** photoelectric effect
- Thus electromagnetic radiation have a dual nature and their particles are photons

12.7 Electron Diffraction

- de Broglie suggested since waves can behave like particles, particles should be able to behave like waves
- **Matter wave:** a moving particle of matter of momentum p will have an associated wave of wavelength λ where

$$\lambda = \frac{h}{p} = \frac{h}{mv}$$

where h is Planck's constant, m is the mass and v is the velocity of the particle. λ is the de Broglie wavelength

Diffraction of Electrons:

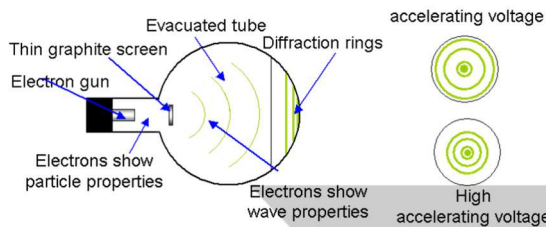

- When a beam of electrons strikes a thin carbon foil, a diffraction pattern is obtained on a screen
- When velocity of electrons in beam was increased by increasing voltage, the rings in the pattern became narrower showing wavelength decreases as velocity is increased, agreeing with de Broglie's equation

12.8 Energy Levels

- The energy of an atom is the total energy of its electrons
- Under normal conditions, an atom is in its **ground state** where it posses the minimum possible energy
- When the atom absorbs energy, the energy of the atom increases and the atom is in an **excited state**
- The **excited state** is unstable so atoms eventually emit absorbed energy bringing the atom back to ground state
- **Transition:** shifting of electrons between energy levels
- Electrons release energy in the form of e-m radiation
- The frequency of the emitted radiation is given by:

$$hf = E_2 - E_1$$

where f is the frequency, E_2 is the energy of the higher level and E_1 is the energy of the lower level

- The frequencies of e-m radiation emitted by electrons when they come down to ground state were found to be discrete showing electrons can only absorb certain discrete values \therefore **energy of an atom is quantized**

12.9 Line Spectra

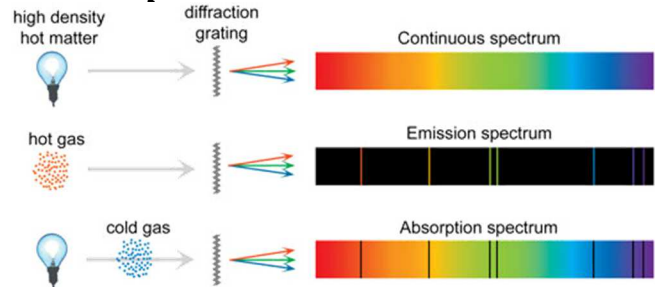

- **Emission line spectra:** the composition of light emitted by a hot gas
 - The frequencies emitted by atoms of a substance when they de-excite from higher to lower energy levels
- **Absorption line spectra:** when white light is passed through a cool gas
 - The frequencies absorbed from a continuous spectrum by the electrons a substance
- The emission and absorption spectra are characteristic of each element

12.10 Band Energies in Solids

- Atoms in solids are close together and electrons from one atom interact with those of neighboring atoms, altering energy level diagrams

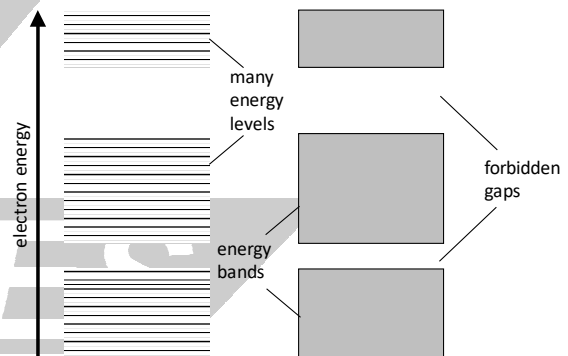

- An electron can have an energy at any level in one of the **energy bands**
- However, it cannot have an energy which lies in the **forbidden gap**

12.11 Band Theory and Electrical Conduction

- In a metal, the **conduction band** is only partially filled with free electrons which gives the metal its conductivity
- In an insulator, the conduction band is unoccupied and the **valence band** is fully occupied

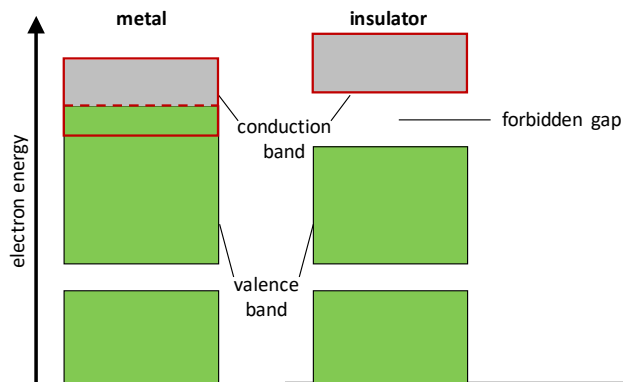

- In a **metal**, the conduction band overlaps with the valence band allowing it to conduct electricity
 - When a metal is heated, resistance increases because there is no increase in density of electrons in the conducting band; instead atoms vibrate more and electrons collide more frequently

- In an **insulator**, there is a large forbidden gap between the valence and conduction band and voltage is insufficient to lift electrons across

- In an **intrinsic semiconductor**, its conduction band is also empty however the gap between the two is very small

- When heated, electrons gain energy to jump into the conduction band and the material will conduct better

- In an LDR, photons of light are absorbed by electrons in valence bands so they jump the gap into the conduction band

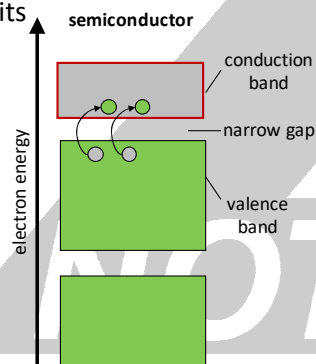

13. PARTICLE & NUCLEAR PHYSICS

13.1 Balanced Equations

- **α decay:** $-\frac{4}{2}\alpha$
 - nucleon no. decreases by 4
 - proton no. decreases by 2
- **β⁻ decay:** $-\frac{0}{-1}\beta^{-}$
 - proton no. increases by 1
- **β⁺ decay:** $-\frac{0}{+1}\beta^{+}$
 - proton no. decreases by 1
- **γ decay:** $-\frac{0}{0}\gamma$
 - proton and nucleon no. unchanged

{S17-P42}

Question 12:

One nuclear reaction that can take place in a nuclear reactor may be represented, in part, by the equation ${}^{235}_{92}\text{U} + {}^1_0\text{n} \rightarrow {}^{95}_{42}\text{Mo} + {}^{139}_{57}\text{La} + 2{}^1_0\text{n} + \dots + \text{energy}$
Data for a nucleus and some particles are given in Fig. 12.1.

nucleus or particle	mass/ u
${}^{139}_{57}\text{La}$	138.955
${}^1_0\text{n}$	1.00863
${}^{139}_{59}\text{p}$	1.00728
${}^0_{-1}\text{e}$	5.49×10^{-4}

Fig. 12.1

(a) Complete the nuclear reaction shown above. [1]

Solution:

Part (a):

According to the law of conservation of mass,

The sum of the number of nucleons always remains the same on both sides of the equation.

Assuming the unknown particle to possess x nucleons,

$$235 + 1 = 95 + 139 + 2(1) + x$$

$$x = 0$$

The only particle in the table to contain 0 nucleons is the electron (${}^0_{-1}\text{e}$).

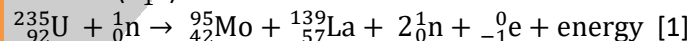

13.2 Mass-Energy Equivalence

- **Einstein's mass-energy relation:**

$$E = mc^2$$

where c is the velocity of light in free space

"mass of a system increases when energy is supplied to it"

- **Mass defect (ΔM):** the difference between the total mass of the individual, separate nucleons and the mass of the nucleus
- **Binding energy (ΔE):** the minimum external energy required to separate all the neutrons and protons of a nucleus. It is also the energy released when the nucleus is assembled from its constituent nucleons
- The binding energy of a nucleus is a measure of how tightly the nucleus is bound and hence how stable it is
- **Binding energy per nucleon** of a nucleus is the ratio of the total binding energy to its nucleon number
- The higher the binding energy per nucleon, the most stable the atom is

13.3 Atomic Mass Unit

- 1u is defined as $\frac{1}{12}$ of the mass of a neutral atom of carbon-12 – approx. equal to 1.661×10^{-27} kg

$$\text{mass excess} = \text{mass (in u)} - \text{nucleon number}$$

13.4 Nuclear Fission & Fusion

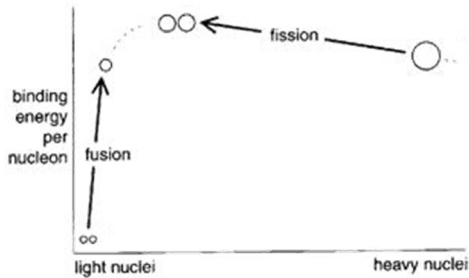

- **Fission:** process in which a massive nucleus splits to form two smaller fragments
 - The large nucleus has a lower binding energy per nucleon so splits into **fission fragments** which have higher binding energy per nucleon ∴ more stable
- **Fusion:** process by which two very light nuclei join together to form a heavier nucleus
 - Two light nuclei fuse so the final binding energy per nucleon will be greater than the original value
- In general, if energy is released in a nuclear reaction, then it shows that the binding energy of the product nuclei is greater than that of the reactants

13.5 Spontaneous & Random Nature

Radioactive processes are **random** and **spontaneous**

- **Random:** impossible to predict and each nucleus has the same probability of decaying per unit time
- **Spontaneous:** not affected by external factors such as the presence of other nuclei, temperature and pressure
- **Evidence on a graph:**
 - Random; graph will have fluctuations in count rate
 - Spontaneous; graph has same shape even at different temperatures, pressure etc.

13.6 Radioactive Decay

- The rate of decay of a given nuclide at any time is \propto to the number (N) of nuclei present at that time

$$\frac{dN}{dt} = -\lambda N$$

- The **activity** (A) of a radioactive sample is the rate at which nuclei decay or disintegrate
- The **decay constant** (λ) is the probability that an individual nucleus will decay per unit time interval

$$A = \lambda N$$

- The above relationship can also be written as:

$$x = x_0 e^{-\lambda t}$$

- where x could represent activity, number of undecayed nuclei or received count

13.7 Exponential Nature

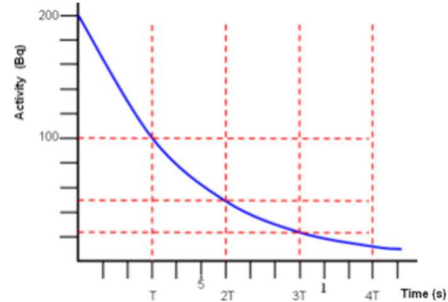

- The activity of a radioactive substance represents an exponential decay
- The **half life** ($t_{1/2}$) of a radioactive is the mean time taken for half of the active nuclei in a sample to decay
 - Assuming the initial activity is 1, at half life the activity would be $\frac{1}{2}$ so:

$$\frac{1}{2} = (1)e^{-\lambda t}$$

- Take \ln on both sides of the equation

$$\ln \frac{1}{2} = -\lambda t_{1/2}$$

- Calculate and rearrange:

$$\lambda = \frac{0.693}{t_{1/2}}$$

- Thus, decay constant is inversely prop. to its half life

14. DIRECT SENSING

14.1 Electronic Sensors

- **Electronic sensor:** consists of a sensing device and a circuit that provides an output voltage

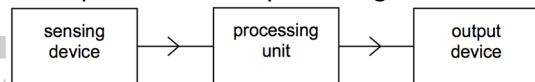

- Information collected by sensing device communicated to the output device through the processing unit.
- The changes in the physical property of the sensing device are converted into corresponding changes in voltage by the processing unit
- The output device responds to variations in voltage

14.2 Light Dependent Resistor (LDR)

- Semi-conducting device whose resistance changes with intensity of light falling on it
- As intensity of light increases, resistance decreases
- Can be used to monitor variation in light intensity
- Variation in resistance with light intensity is non-linear

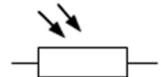

14.3 Thermistor

- Resistance of a thermistor with negative temperature coefficient decreases rapidly with increase in its temp.
- Can be used to monitor variation in temperature
- Variation in resistance with temperature is non-linear

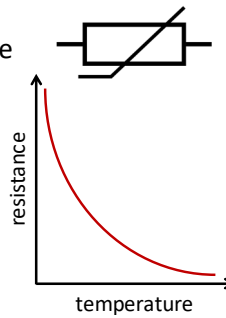

14.4 Strain Gauge

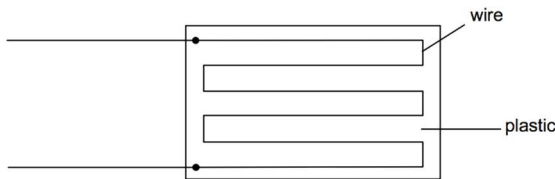

- Consists of a fine metallic wire of uniform cross-sectional area sealed in a small rectangular piece of plastic
- When the plastic is stretched, the wire also gets stretched and hence its length increases while cross-sectional area decreases slightly (consider negligible)
- This will increase its resistance because $R = \frac{\rho L}{A}$
- $\Delta R \propto \Delta L$
- Strain is directly proportional to change in resistance

14.5 Piezo-Electric Transducer

- A **transducer** is a device that converts energy from one form to another
- A piezo-electric crystal (such as quartz) is an example of a transducer that consists of a lattice of +ve and -ve ions
- Under normal conditions, the centers of the positive and negative charges coincide
- When the crystal is stressed, the centers of the +ve and -ve charges will be displaced causing a voltage to be generated across the crystal - the **piezo-electric effect**
- The magnitude of the voltage generated depends on the magnitude of the pressure applied

Application in a Simple Microphone

- When a sound wave is incident on a quartz crystal, it will be subject to a pressure changing between maximum and minimum alternately
- It will generate an alternating voltage across the crystal
- If a transducer is used as a sensing device, a processing unit is not required since variations in its property are directly converted into variations in voltage generated

14.6 Processing Unit

- Processing unit converts variations of resistance of sensing devices into corresponding variations in voltage
- A potential divider circuit can be used as a

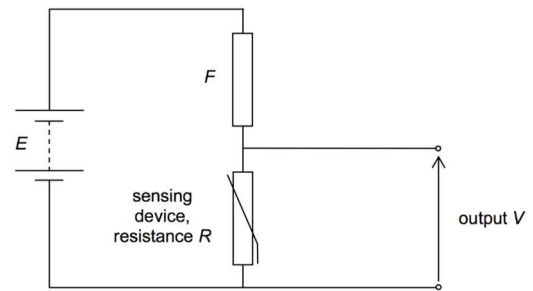

processing unit

- Output voltage is given by:

$$V = \frac{R}{F+R} \times E$$

- Thus, as R increases, output voltage also increases
- Output can be connected across F and the opposite would occur

15. ELECTRONICS

15.1 Operational Amplifier

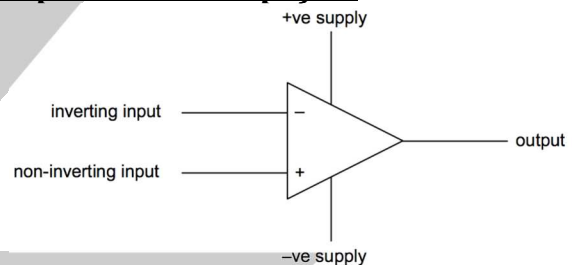

- The output is proportional to the difference between the two input voltages, given by:

$$V_{out} = A_0(V^+ - V^-)$$

where V^+ and V^- are the voltages at the non-inverting and inverting terminals and A_0 is the open-loop gain

- When the calculated output of an op-amp is greater than the supply voltage, the op-amp is said to be saturated and the output is equal to the supply voltage
- If the output is not saturated, the two inputs are virtually at the same voltage
- If $V^+ > V^-$, then the output is positive
- If $V^+ < V^-$, then the output is negative

15.2 Ideal Operational Amplifier Properties

- **Infinite input impedance:** no current enters or leaves either of the inputs
- **Zero output impedance:** whole of output voltage is provided across the output load
- **Infinite open-loop gain:** even if only slight difference between input voltages, op-amp will be saturated and output will equal the supply voltage
- **Infinite bandwidth:** all frequencies are amplified by the same factor
- **Infinite slew rate:** there is no delay between changes in the input and consequent changes in the output
- **Zero noise contribution:** ideal op-amp does not produce any noise itself

15.3 Comparator

- An op-amp can be used to compare the two inputs and the output will switch from one saturation level to the other when one of the input voltages change
 - The inverting and non-inverting inputs are derived from two potential dividers so only very small current flow
- This example shows a comparator being used to operate a small lamp when it gets dark

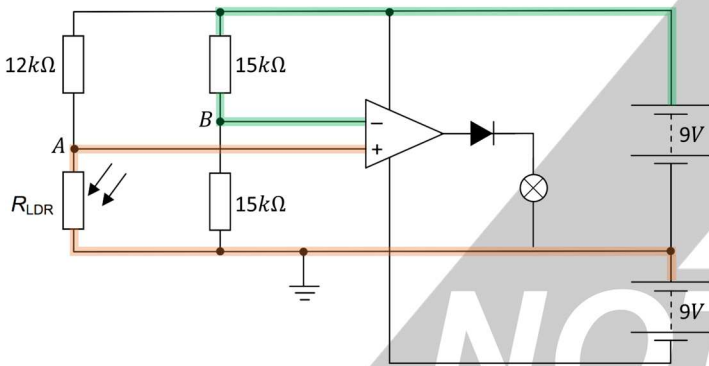

- **In daylight**, LDR has low resistance ($3k\Omega$) & non-inverting voltage is small causing op-amp to be negatively saturated ($-9V$). Diode reverse-biased: lamp doesn't light

$$\text{At A: } \frac{3}{12+3} \times 9 = 1.8V \quad \text{At B: } \frac{15}{15+15} \times 9 = 4.5V$$

$$1.8 - 4.5 = -2.7 \therefore \text{ -ve saturation}$$

- **In darkness**, LDR has high resistance ($18k\Omega$) & non-inverting voltage is high causing op-amp to be positively saturated. Diode forward-biased: lamp lights

$$\text{At A: } \frac{18}{12+18} \times 9 = 5.4V \quad \text{At B: } \frac{15}{15+15} \times 9 = 4.5V$$

$$5.4 - 4.5 = 0.9 \therefore \text{ +ve saturation}$$

- The LDR could be replaced by other sensors to provide alternative sensing devices e.g. thermistor

15.4 Negative Feedback

- A fraction β of the output is fed back to the inverting input of the op-amp.
- Though the negative feedback reduces the voltage gain of the amplifier, it will improve the accuracy and control

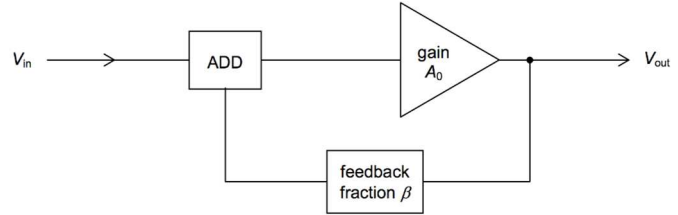

Advantages of negative feedback:

- Increases the range of frequencies over which the voltage gain is constant (increased bandwidth)
- The amplifier is more stable
- There is less distortion

15.5 Inverting Amplifier

- The input voltage is applied to the inverting input through the input resistance R_{in}
- The non-inverting input is connected to zero-volt
- Negative feedback is applied to the inverting input through a resistor R_f
- The non-inverting input is at **virtual earth**:
 - the op-amp has very large gain
 - and the non-inverting input is earthed
 - If the amplifier is not to saturate, inverting input must be (almost) at earth potential.

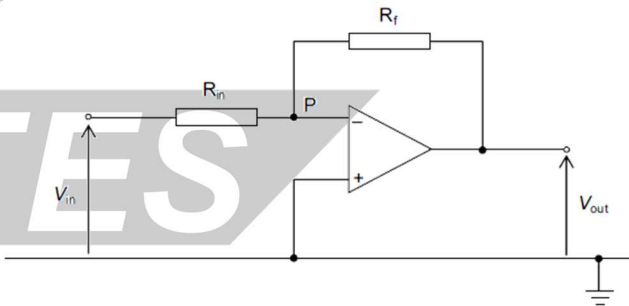

Since the input resistance of the op-amp is infinite, current in R_{in} = current in R_f

hence

$$\frac{\text{p. d. across } R_{in}}{R_{in}} = \frac{\text{p. d. across } R_f}{R_f}$$

the potential at P is zero (virtual earth) so

$$\frac{V_{in} - 0}{R_{in}} = \frac{0 - V_{out}}{R_f}$$

\therefore the overall voltage gain is given by

$$\text{voltage gain} = \frac{V_{out}}{V_{in}} = -\frac{R_f}{R_{in}}$$

15.6 Non-Inverting Amplifier

- The input voltage is applied to the non-inverting input
- Negative feedback is provided by a potential divider consisting of resistors R_1 and R_f

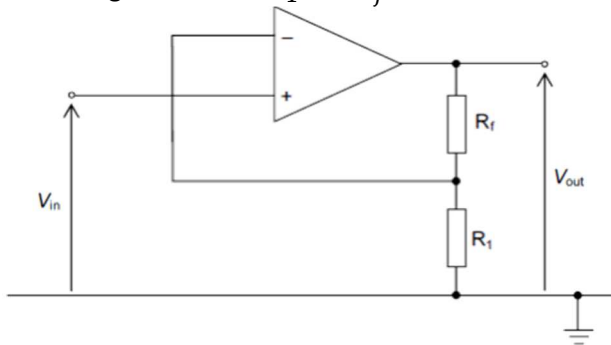

As before, the current in the two resistors are equal and can be written as

$$\frac{V_{out}}{(R_f + R_1)} = \frac{V_{in}}{R_1}$$

cross multiply and rearrange

$$\frac{V_{out}}{V_{in}} = \frac{R_f + R_1}{R_1}$$

∴ the overall voltage gain is given by

$$\text{voltage gain} = \frac{V_{out}}{V_{in}} = 1 + \frac{R_f}{R_1}$$

15.7 Relays

- Output of an op-amp cannot exceed 25mA and 15V so in order to operate electronic circuits which require large currents, a relay may be used at output of the op-amp

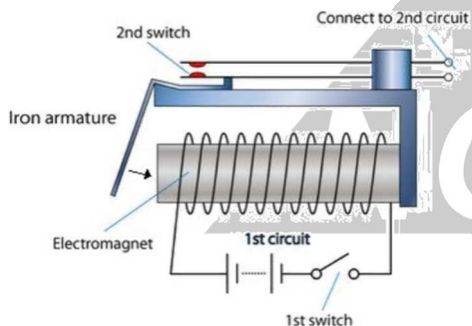

- A relay is an electromagnetic switch that can switch on or off a large current using a small current
- Consists of an electromagnet, which when energized by the small current, operates the contact, switching on or off the large current

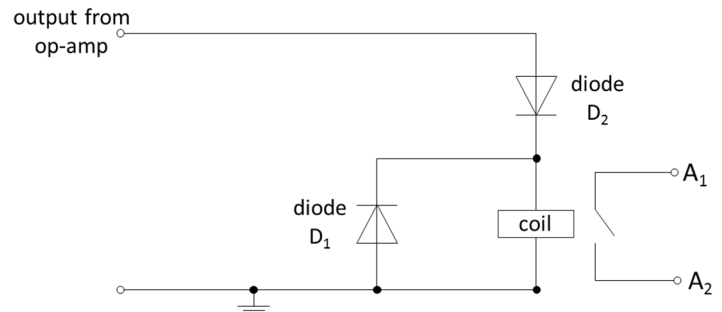

- The diode D_2 conducts only when output of the op-amp is positive with respect to the earth
- A back e.m.f is generated by the coil when current in the relay is switched off which may damage the op-amp
- The diode D_1 connected across the coil protects the op-amp from back e.m.f by conducting this current

15.8 Light Emitting Diode (LED)

- An LED is a diode which emits light only when it is forward biased hence can be used to indicate state of output of op-amp
- The maximum allowed current through a forward biased LED is 20mA and has a breakdown voltage of about 5V
- Hence, to protect an LED from large current, a resistor is connected in series with it

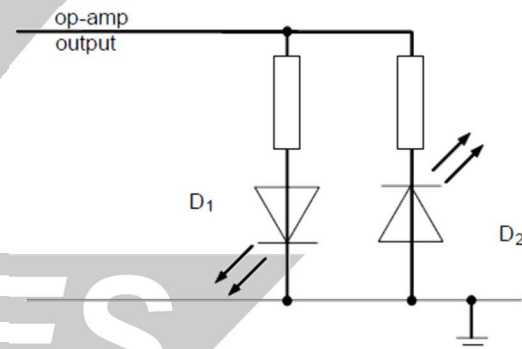

- When output is positive, the diode D_1 is forward biased and will conduct, emitting light
- When output is negative, the diode D_2 is reverse biased and will conduct, emitting light

15.9 Calibration Curve

- To measure the output voltage of an op-amp, an analogue or digital voltmeter is required
- Using a calibration curve, we can match this output voltage to a physical quantity
- E.g.: to set the temperature for frost warning, a calibration curve between the temperature of the thermistor and the corresponding output voltage
- The output voltage corresponding to the frost warning temperature can be obtained from calibration curve

16. COMMUNICATION

16.1 Radio Waves

- Radio systems start with sound passing into a microphone, the sound signal is converted into a radio signal and at the end, converted back into a sound signal
- The **information signal** is transmitted with a **carrier wave**; higher frequency so shorter aerial required and different frequencies for different stations

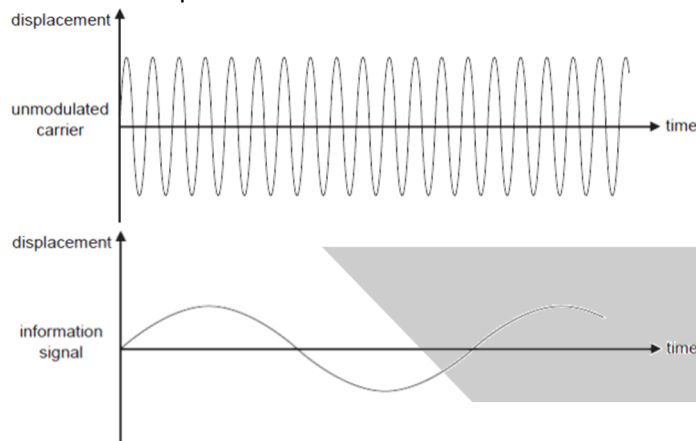

- Modulation is the variation of either the amplitude or the frequency of the carrier wave

Advantages of Modulation over Direct:

- Shorter aerial required
- Longer transmission range
- Less attenuation
- Allows more than one station in a region
- Less distortion

16.2 Amplitude Modulation (AM)

- For amplitude modulation (AM), the amplitude of the carrier wave is made to vary in synchrony with the displacement of the information signal
- The frequency of the carrier wave does not vary

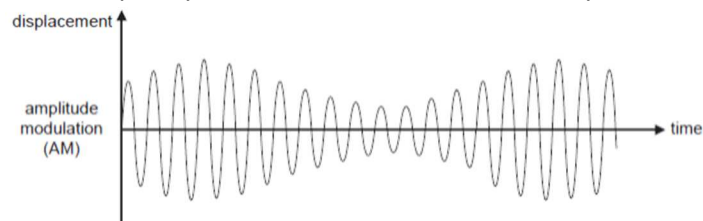

- The amplitude of the signal must be less than half of the amplitude of the carrier wave
- The variation in the amplitude of the carrier wave is a measure of the displacement of the information signal
- The rate at which the carrier amplitude varies is equal to the frequency of the information signal

- An amplitude modulated wave consists of three components:
 - Original carrier wave of frequency f_c and amplitude A_c
 - A wave of frequency $f_c - f_a$ and amplitude $\frac{A_a}{2}$
 - A wave of frequency $f_c + f_a$ and amplitude $\frac{A_a}{2}$

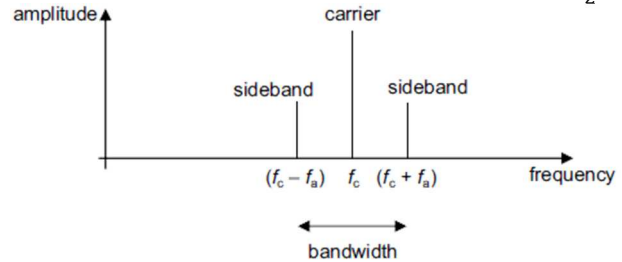

- The central frequency f_c is that of the high-frequency carrier wave
- The other two are known as sidebands
- The range of frequencies from the min to max in modulated carrier wave is called its **bandwidth**

$$(f_c + f_a) - (f_c - f_a) = 2f_a$$

16.3 Frequency Modulation (FM)

- For frequency modulation (FM), the frequency of the carrier wave is made to vary in synchrony with the displacement of the information signal
- The amplitude of the carrier wave does not vary

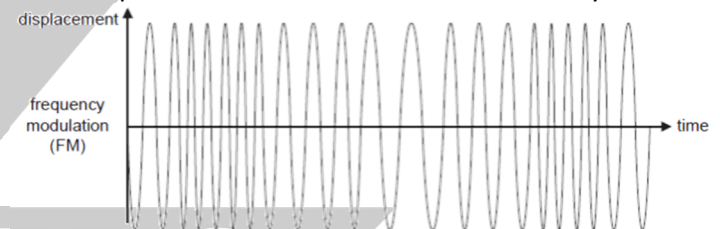

- The change in frequency of the carrier wave is a measure of the displacement of the information signal
- The rate at which the carrier wave frequency is made to vary is equal to the frequency of the information signal

16.4 Comparison of AM and FM

Amplitude Modulation (AM)	
Pros	Cons
<ul style="list-style-type: none"> • Smaller bandwidth so more stations available in frequency range • Greater area covered by one transmitter • Cheaper radio sets 	<ul style="list-style-type: none"> • Requires a high power transmitter • More electrical noise and interference

Frequency Modulation (FM)	
Pros	Cons
<ul style="list-style-type: none"> • Less electrical noise and interference • Greater bandwidth produces better quality sound 	<ul style="list-style-type: none"> • Shorter range • More complex circuitry • More expensive

16.5 Analogue and Digital Signals

- **Noise:** random, unwanted signal that adds to and distorts a transmitted signal
- **Attenuation:** progressive power loss in the signal as it travels along the transmission path
- **Analogue signal:** signal has same variation (with time) as the data and is continuously variable
- If an analogue signal is transmitted over a large distance, it will be attenuated and pick up noise. For it to continue to travel, the signal is amplified by a repeater amplifier however the noise would also be amplified causing the signal to become very noisy

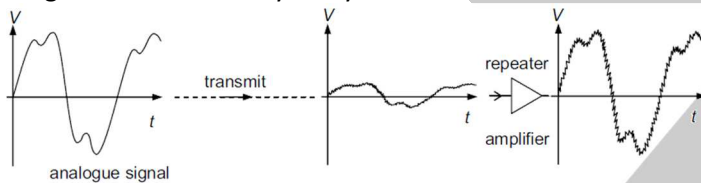

- **Digital signal:** consists of a series of 'high's and 'low's' and has no intermediate values
- Digital signals are made up of only highs and lows so even though they get noisy during transmission, regenerator amplifiers reproduce the digital signal and hence 'filter out' the noise

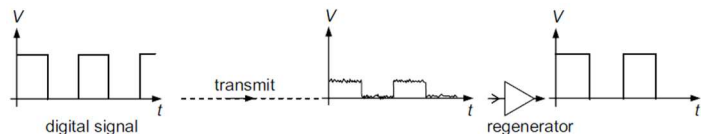
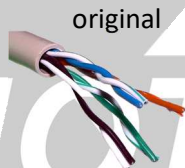

- **Advantages of Digital Signals:**
 - Signal can be regenerated and noise can be eliminated
 - Extra data can be added to check for errors
 - Multiplexing: digital signals from a large number of different sources can be made to share the same path
 - Digital circuits are more reliable & cheaper to produce
 - Data can be encrypted for security

16.6 Analogue-to-Digital Conversion

- In digital transmission, the analogue signal is converted to digital using an analogue-to-digital converter (ADC)
- When received, it is converted back to analogue using a digital-to-analogue converter (DAC)
- To convert an analogue signal into digital, its voltage value is measured at regular intervals (sampling)
- These instantaneous voltage values (samples) are converted into binary numbers representing their value

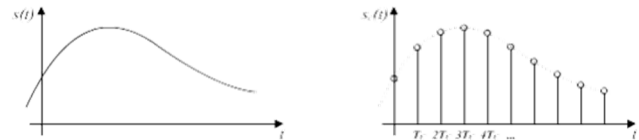

- The binary bit 1 represents a 'high' voltage and 0 represents a 'low' hence a digital signal is made of a series of high and low voltages
- The binary system has base 2 and each digit of a binary number is called a bit
- The bit on the left-hand side of a binary number is the **most significant bit (MSB)** and has the highest value
- The **number of bits per sample** limits the number of possible voltage levels (with 4 bits there are $2^4 = 16$ levels; with 8 bits, there are $2^8 = 256$ levels)
- A higher **sampling frequency** means that more information can be gathered from the analogue signal
- **Improving reproduction of input signal:**
 - increase number of bits in digital number at each sampling so that step height is reduced
 - increase sampling frequency so width of step reduced
- When transmitting the digital signal, a **parallel to serial converter** can be used to take all the bits and transmit them one after another down a single line rather than having e.g. 8 cables for an 8bit number (cheaper)
- When received, a **serial to parallel converter** can convert the signal back to the original form

16.7 Channels of Communication

Wire Pairs:

e.g. linking a (land) telephone to the (local) exchange

- The potential difference between the two wires is the signal
- Each wire acts as an aerial and picks up unwanted electromagnetic waves and distorts signal
- Attenuation of the signal is high since energy is lost as heat due to resistance of cable as well as EM radiation
- **Cross-linking/cross-talk:** signal in one wire pair is picked up by a neighboring wire pair

Coaxial Cable:

e.g. connecting an aerial to a television

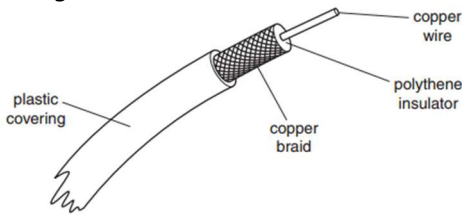

- Function of copper braid:
 - Acts as 'return' for the signal
 - Shields inner core from noise/interference & cross-talk

Wire-pairs	Coaxial cable
<ul style="list-style-type: none"> • Cheap and convenient • Signal attenuated greatly • Have low bandwidth • Picks up noise and interference • Suffer from cross-talk • Have low security 	<ul style="list-style-type: none"> • More expensive • Less attenuating • Higher bandwidth • Less electrical interference and noise • Little cross-talk • More secure

Radio and Microwave Link:

e.g. linking a ground station to a satellite

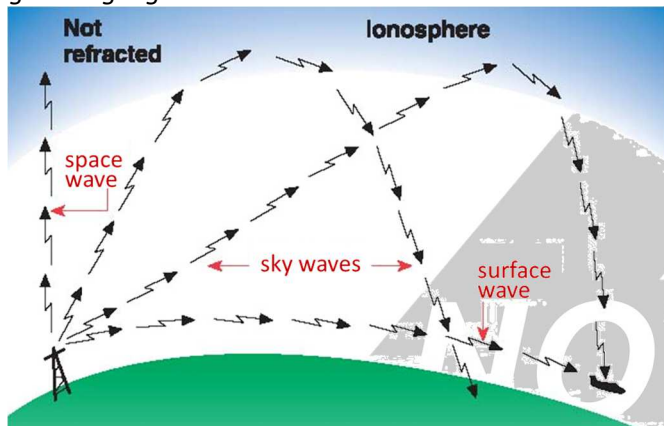

- **Surface waves** travel close to the surface of the earth and diffract around it due to long wavelengths
- **Sky waves** travel in the atmosphere in straight lines, reflecting back and forth between the ionosphere and Earth's surface hence can go a long distance
- **Space waves** have a higher frequency so pass through the ionosphere and transmit in the line-of-sight
- **Disadvantages of using ionospheric reflection:**
 - Unreliable because ion layers vary in height/density
 - Cannot carry info. required as bandwidth too narrow
 - Coverage limited and reception poor in hilly areas

	Frequency Range	Communication method & waveband	Distance travelled
Surface wave	Up to 3MHz	LW and MW radio in LF band	Up to 1000km
Sky wave	3-30 MHz	SW radio in HF band	Global
Space wave	30-300 MHz	FM radio in VHF band, TV & mobile in UHF	Line-of-sight
Microwave	1-300 GHz	Microwave, satellite & WiFi in SHF and EHF	Line-of-sight

Microwave Link:



- The transmitter focuses the radio waves towards the receiver by using an aerial shaped as a dish as without it, the strength of the signal would decrease greatly
- Each dish points towards a dish on another tower and transmit microwaves back and forth in line-of-sight
- Microwaves are secure and difficult to tap into as the beam travelling is narrow and doesn't spread

Optic Fibers:

- Optic fibers are thin flexible glass rods used to carry digital info. in the form of pulses of infra-red radiation transmitted using total internal reflection
- Transmitted with infra-red radiation because it has lower attenuation than for visible light

Advantages:

- Large bandwidth so can carry more information
- Low attenuation of signal
- Low cost
- Smaller diameter, less weight: easier handling/storage
- High security/no crosstalk
- Low noise/no electromagnetic interference

16.8 Satellite Communication

- Carrier wave transmitted from Earth to satellite
- Satellite receives greatly attenuated signal
- Signal amplified and transmitted back to Earth at a different carrier frequency e.g. 6/4, 14/11 and 30/20
- Different frequencies prevent swamping of uplink signal

- High frequencies in GHz used:
 - no ionospheric reflection
 - large information carrying capacity

Polar Satellite	Geostationary Satellite
<ul style="list-style-type: none"> • Travels from pole to pole with a shorter period • Satellite passes over every area on earth • At smaller height above the earth and can detect objects of smaller detail • Difficult to track down the satellite • Has smaller delay times 	<ul style="list-style-type: none"> • Satellite rotates with the same period as earth • Cover only one third of the earth's surface • In equatorial orbit, from west to east with period of 24 hours • Easy to track down the satellite • Large delay time
Polar Satellite	Geostationary Satellite
<ul style="list-style-type: none"> • Not always in the same position relative to earth so dishes must be moved • Cannot be used for continuous comm. • Used for remote sensing 	<ul style="list-style-type: none"> • Remains in fixed position above point on equator so no need to move dish • Can be used for continuous comm. • Continuously monitor climatic change

16.9 Signal Attenuation

- Attenuation is the gradual decrease in power of a signal the further it travels
- Power ratios are expressed in decibels (dB) because the numbers involved are smaller and cover a wider range
- Attenuation/amplification between two positions can be expressed in dB by:

$$\text{no. of decibels} = 10 \lg \left(\frac{P_{out}}{P_{in}} \right)$$

- If value is positive, there is an increase in power hence the signal has been amplified
- If value is negative, there is a decrease in power hence the signal has been attenuated
- Attenuation of cables is given as attenuation per unit length and is found by:

$$\text{Attenuation per unit length (dB km}^{-1}\text{)} = \frac{\text{attenuation (dB)}}{\text{length of cable (km)}}$$

- Signal must be distinguishable above the level of noise and this can be measured by the signal-to-noise ratio:

$$\text{signal-to-noise ratio} = 10 \lg \left(\frac{\text{signal power}}{\text{noise power}} \right)$$
- Repeaters amplify both signal & noise so signal-to-noise ratio remains constant however regeneration of digital signal removes most noise ∴ high signal-to-noise ratio

17. MEDICAL IMAGING

17.1 X-Ray Production

- X-rays are a form of electromagnetic radiation
- Produced when high-speed electrons hit metal targets

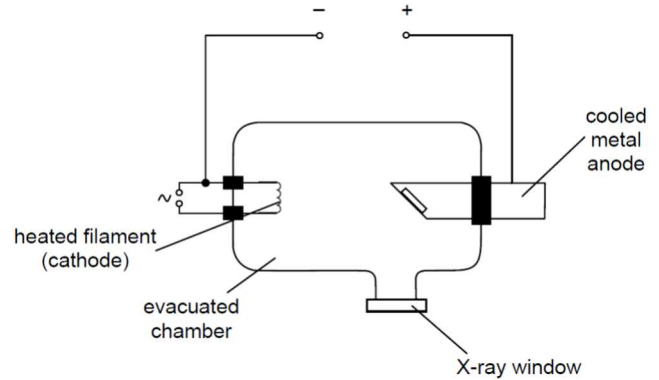

• Production of X-rays:

- Heated filament undergoes thermionic emission releasing high-speed electrons
- p.d between cathode & anode causes e's to accelerate
- Electrons bombard metal target emitting X-rays which leave through the window
- Some kinetic energy of electrons transferred into the metal target as thermal energy
- Metal target is cooled by water or spun around to increase target area
- **Tube Current:** the rate of arrival of electrons at a metal target

Intensity	Hardness
Depends on no. of e's hitting anode per unit time	Depends on the acceleration of electrons
Proportional to the heater current	Proportional to p.d. between anode & cathode
A more intense X-ray produces an image quicker	A harder X-ray has more penetrating power

- Some 'soft' X-rays are always produced which cannot fully pass through the patient and contribute to the total radiation dose of the patient.
- To reduce the radiation dose hence cut off 'soft' X-rays, an aluminium filter used to absorb them

17.2 X-Ray Spectrum

- X-rays emerge from the tube with a range of energies as represented in the spectra below

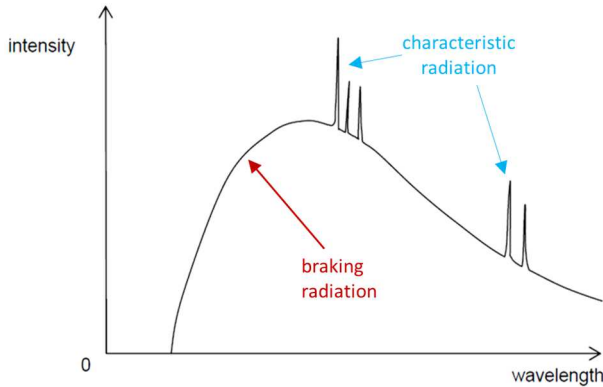

- The spectra is made up of two components:
 - **Braking radiation:** X-ray photons released when e^- decelerate as it strikes anode, attracted by the nucleus of an atom in the anode and loses energy
 - **Characteristic radiation:** rearrangement of e^- s in anode when a high-speed e^- strikes, excites orbital e^- s which then de-excite, emitting photons & giving rise to spectrum lines; specific to material of anode

17.3 X-Ray Imaging

- X-ray radiation blackens photographic plates in the same way as visible light
- Degree of blackening depends on total X-ray exposure
- Mostly used to distinguish bones from tissue because bones have a higher density than surrounding tissue
- Can be used to identify organs if the densities of surrounding tissues are sufficiently different

17.4 X-Ray Quality

- **Sharpness** is the ease with which the edge of a structure can be determined
- Improving sharpness of X-Ray:
 - Reduce the area of target anode

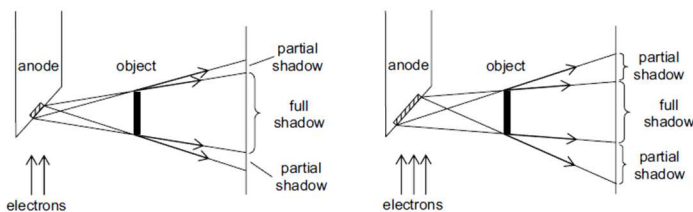

- Reduce aperture size (window): reduces beam width
- Place lead grid in front of photographic film: absorbs scattered X-rays and reduces partial image

- **Contrast** is the visual difference between the areas of blackening and light
- Improving contrast of X-Ray:
 - Increase Exposure time
 - Use harder X-Rays: increases penetration power
 - Reduce scattering of X-Ray beam
 - Use fluorescent 'contrast medium'

17.5 X-Ray Intensity

- In medium where X-Rays are absorbed, intensity of a parallel X-Ray beam decreases by a constant fraction in passing through equal small thicknesses of the medium.
- This gives rise to an exponential decrease in the intensity of the transmitted beam:

$$I = I_0 e^{-\mu x}$$

- I is the instantaneous intensity of the X-ray beam
- I_0 is the initial intensity of the X-Ray beam
- x is the thickness of the medium passed by X-Ray
- μ is the **linear absorption coefficient** unique to medium, dependent on photon energy and in mm^{-1}
- This can be represented graphically:

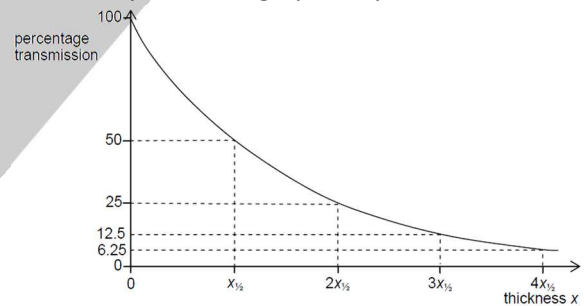

- **Half-value Thickness ($x_{1/2}$):** thickness of the medium required to reduce the transmitted intensity to one half of its initial value
- Related to the linear absorption coefficient by:

$$x_{1/2} \times \mu = \ln 2$$

17.6 Computed Tomography (CAT/CT Scan)

- X-Ray imaging only produces a 2 dimensional image with no impression of depth, cannot tell if tissue is near to the surface or deep within the body
- Tomography is a procedure which forms a 3 dimensional plane of the object
- The diagram below shows the procedure

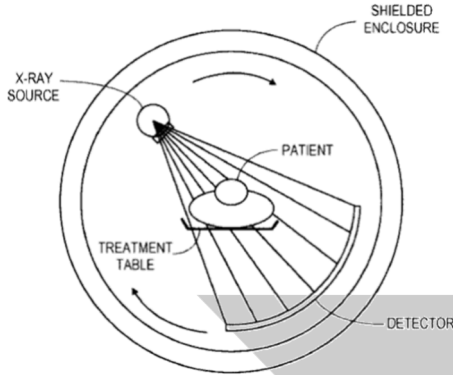

- Putting together several planes produces a whole 3 dimensional image which can be rotated

17.7 Voxel Development in CT Scans

- **Voxel:** a small cube in a three-dimensional image
- The number in each square is the density that the computer will register for that section of the object
- As the scanner goes around each part has a different density which the computer can model
- The computer then put these together to form a 3 dimensional shape

17.8 Building the Image

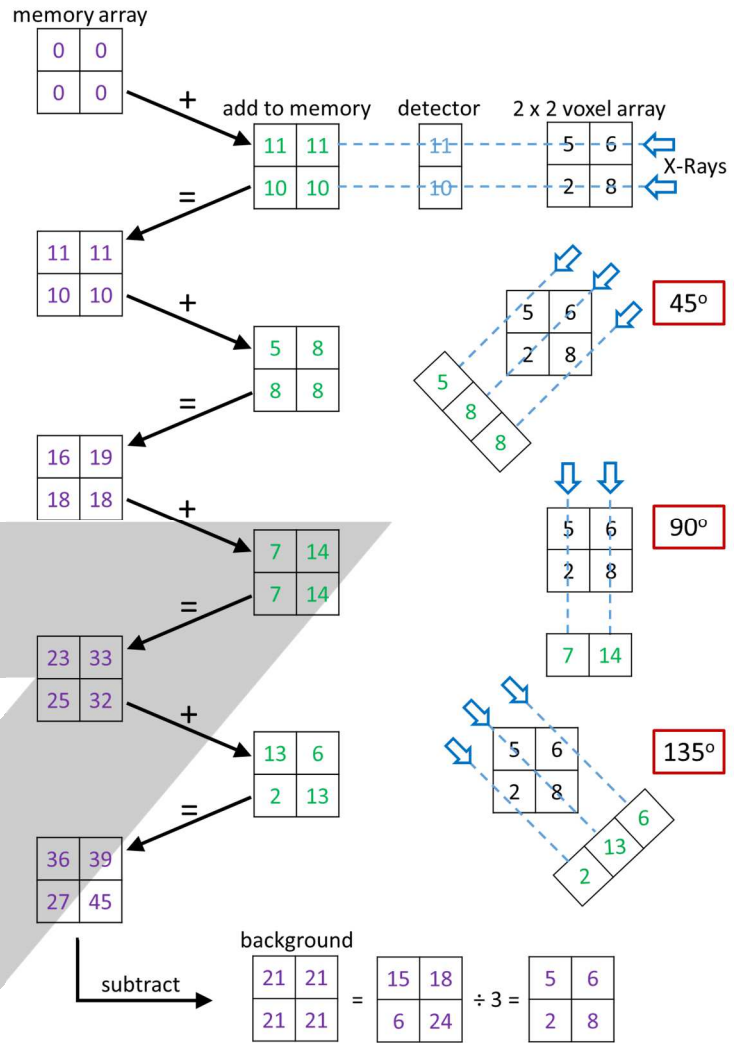

- For a well-defined image in a CT scan, we need voxels to be small and to do so:
 - X-ray beams must be well collimated so that it consists of parallel ray – rays must not spread
 - Detector must consist of regular array of tiny detecting elements – smaller the detector the better the image
- **Advantages of a CT scan:**
 - Produce images that show three-dimensional relationships between different tissues
 - Can distinguish tissues with quite similar densities

17.9 Ultrasonic Waves

- Ultrasound is any sound wave that has a frequency above the upper limit of human hearing, 20kHz
- Piezo-electric transducers can be used to record and produce ultrasonic waves
- A diagram of a Piezo-electric transducer:

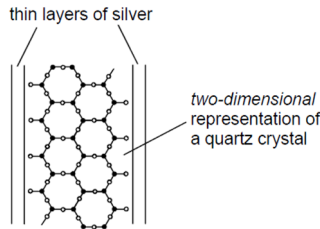

- Quartz crystal is the macromolecule formed by SiO_2

Generating Ultrasonic Waves:

- Charged atoms of a transducer in an electric field move closer to oppositely charged plates and the overall crystal either compresses or extends:

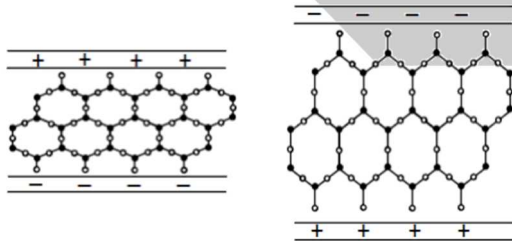

- When an alternating voltage with frequency f is applied to the crystal, it causes it to contract and expand at the same frequency of f
- This acts as the vibrating source of ultrasound waves

Receiving Ultrasonic Waves:

- Ultrasonic waves change pressure in medium
- Charged atoms in crystal shift position closer to plates
- Opposite charges induced in the silver plates
- Induced potential difference across the plates
- Potential difference fluctuates which can be processed

17.10 Reflection of Ultrasonic Waves

- Ultrasound requires ultrasonic waves to pass from one medium to another
- When a beam of ultrasound wave reaches a boundary between two different media, the beam is partially refracted and partially reflected

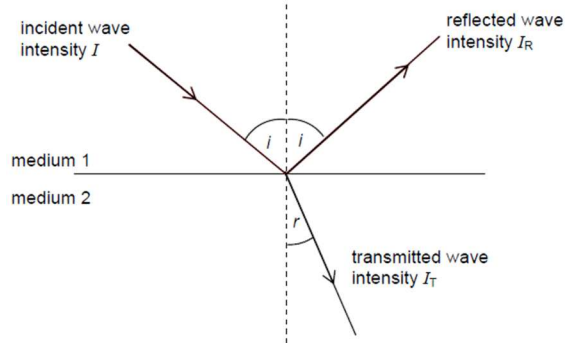

- From the law of conservation of energy:

$$I = I_R + I_T$$

- **Specific Acoustic Impedance (Z):** product of density of medium and speed of sound in medium

$$Z = \rho c$$

- Between two media, the difference in acoustic impedance determines the fraction of incident intensity that is reflected

- **Intensity Reflection Coefficient (α):** ratio of intensity of reflected wave and intensity of incident wave

$$\alpha = \frac{I_R}{I} = \frac{(Z_2 - Z_1)^2}{(Z_2 + Z_1)^2}$$

- Comparing acoustic impedances ($\frac{I_R}{I}$):

- Very large fraction reflected at air-tissue boundary
- Large fraction reflected at tissue-bone boundary
- Very little reflected at boundary between soft tissues
- A gel is applied before carrying out scan because when wave travels in or out of the body, there is:
 - Very little transmission at an air-skin boundary
 - Almost complete transmission at a gel-skin boundary because acoustic impedance of gel & skin very similar

17.11 Attenuation of Ultrasonic Waves

- Similar to X-Rays ultrasonic waves are also absorbed by the medium in which they are passing through
- Also follows the same decay equation as X-Rays:

$$I = I_0 e^{-kx}$$

- Note the constant is different
- k is called the **absorption coefficient**

17.12 Ultrasound Imaging Procedure

- Transducer is placed in contact with skin and a gel acting as a coupling medium
- Pulses of ultrasound are directed into the body
- The wave is reflected at boundary between tissues
- The reflected pulse is detected and processed
- The time for return of echo gives information on depth
- Amount of reflection gives information on structures

Two techniques for display:

- **A-scan:** measures distance of different boundaries from transducer held in one position graphically
- **B-scan:** repeats A-scan multiple angles to form 2 dimensional image

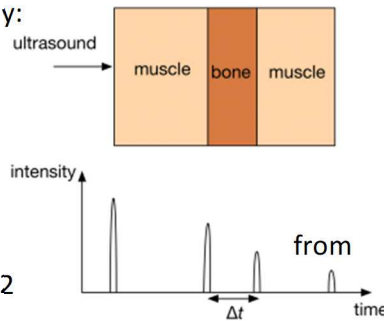

17.13 Nuclear Magnetism

- Atomic nuclei with an odd number of protons behave as tiny magnets when introduced to a magnetic field
- Hydrogen nucleus (proton) is used most because it is abundant in all organic tissues
- When there is no magnetic field:
 - All protons are aligned randomly
- When magnetic field is introduced:
 - Most protons align themselves with 'north' facing 'south' – stable low energy state
 - Some protons align themselves in the opposite way with 'south' facing 'south' – unstable high energy state

17.14 Nuclear Magnetic Resonance

- Aligned protons are not stationary; they spin on their axis of rotation
- **Atomic spin:** is a fundamental property (like charge or mass) of a subatomic particle that defines how the particle rotates on its axis
- **Precession:** the movement of the axis of rotation of a spinning object (proton) around another external axis
- **Larmor Frequency (ω_0):** the angular frequency of the circular path of precession of the object (proton)

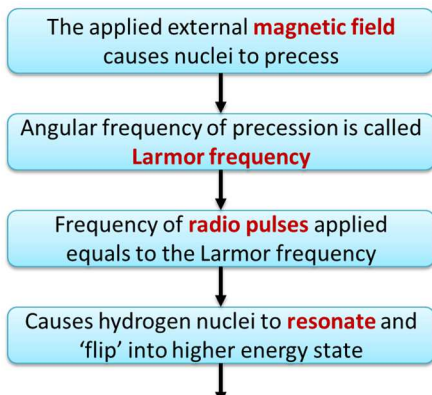
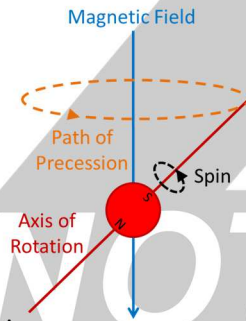

Larmor frequency = radio frequency = resonant frequency

- MRI Scanners use a very strong external magnetic field causing ω_0 to be in radio frequency range

17.15 Relaxation Times

- The protons in high energy state are unstable so must 'relax' and come back to lower energy state
- The excess energy is transmitted back as radio waves which can be detected
- The time taken for these radio waves to be detected determines the relaxation time
- **Relaxation time:** time taken for a nucleus to fall back to a lower energy state
- Relaxation times depend on environment of the protons:
 - Water and watery tissues: several seconds – high
 - Fatty tissues: hundreds of milliseconds – low
 - Cancerous tissues: intermediate

17.16 MRI Scanning

- A **large uniform magnetic field** causes all protons in body to have same Larmor frequency
- A **non-uniform magnetic field** is applied to locate a particular position of a proton within the person

Procedure of an MRI:

- A strong, constant magnetic field is applied along body
- Hydrogen nuclei precess about the direction of the field
- A radio frequency (r.f.) pulse is applied
- The pulse is at the Larmor frequency which causes resonance in hydrogen nuclei
- On relaxation, the nuclei de-excite and emit pulse of r.f.
- r.f. pulses are detected, processed and displayed
- A calibrated non-uniform field enables position of nuclei to be located and for location of detection to be changed

17.17 Comparing Medical Imaging Methods

	Advantages	Disadvantages
X-Ray	<ul style="list-style-type: none">• Sharp image• Improvable contrast• Can form image where air is trapped (lung)	<ul style="list-style-type: none">• Equipment heavy and not portable• May cause ionization and damage tissues
Ultrasound	<ul style="list-style-type: none">• Portable equipment• Less harmful than X-ray• Can break kidney stones• Used for treatment of sprained joints	<ul style="list-style-type: none">• Cannot be used to form image where air is trapped e.g. lungs• Image not sharp due to refraction• Rapid movements in tissue – may damage
MRI	<ul style="list-style-type: none">• Clearer image than ultrasound• Image can be studied in any plane or direction• Lower health risk than X-ray/ultrasound	<ul style="list-style-type: none">• Equipment heavy and not portable• Requires patient to remain still• If patient body contains metal, heated/attracted• Pacemakers may be upset by magnetic field

NOTES

[Online Classes : Megalecture@gmail.com](mailto:Megalecture@gmail.com)
www.youtube.com/megalecture
www.megalecture.com

www.youtube.com/megalecture

MEGA LECTURE

www.megalecture.com